

A COMPARISON OF CURRENT PRODUCTION 6L6GC TUBES ®2013

Each tube in this comparison was installed in the same custom built, fixed bias single-ended guitar amplifier in order to obtain the voltage gain measurements and conduct listening tests. Each tube sample used for comparison was chosen because it measured in the middle range of idle plate current draw at the same operating point set by a Maxi-Matcher Digital Tube Tester:

$I_a \approx 24\text{mA}$ ("mid range" DC plate current value measured in Maxi-Matcher)
 $V_a = 400\text{ VDC}$ (Maxi-Matcher's given plate voltage)
 $V_{g1} = -48\text{ VDC}$ (Maxi-Matcher's given control grid voltage)

An audio frequency generator was used to sweep from 10Hz to 20kHz with the input voltage measured at the 6L6GC control grid (g1) and the output voltage measured at the output transformer's secondary winding while connected to an 8 ohm load. The 50Hz measurement was used for Lows, 700 Hz for mids and 6kHz for highs.

(*Physical Comparison Drawings are drawn to scale.)

Tube Brand / Electrical Ratings	Measured Voltage Gain (dB)	Physical Comparison*
6L6GC Winged C / SED Made in Russia Maximum Ratings $V_a = 500\text{V}$ $V_{g2} = 500\text{V}$ $W_a = 30\text{W}$ Filament $V_f = 6.3\text{V}$, $I_f = 0.9\text{A}$	<p>Guitarist's Opinion: This tube has a straightforward, focused tone with an emphasis on highs for sizzling leads.</p>	 T-6L6GC-WC Seated Height = 3.66" Glass Diameter = 1.53"
6L6GC STR Tung-Sol Reissue Made in Russia Maximum Ratings $V_a = 500\text{V}$ $V_{g2} = 500\text{V}$ $W_a = 30\text{W}$ Filament $V_f = 6.3\text{V}$, $I_f = 0.9\text{A}$	<p>Guitarist's Opinion: This tube is well balanced, smooth and warm.</p>	 T-6L6GC-STR-T Seated Height = 3.19" Glass Diameter = 1.44"
6L6GC JJ Electronic Made in Slovakia Maximum Ratings $V_a = 500\text{V}$ $V_{g2} = 450\text{V}$ $W_a = 30\text{W}$ Filament $V_f = 6.3\text{V}$, $I_f = 0.9\text{A}$	<p>Guitarist's Opinion: This tube is fat and smooth with some sparkle on the top-end. It offers more bite than most.</p>	 T-6L6GC-JJ Seated Height = 3.88" Glass Diameter = 1.44"
6L6GC Tube Amp Doctor Made in China Maximum Ratings $V_a = 550\text{V}$ $V_{g2} = 450\text{V}$ $W_a = 30\text{W}$ Filament $V_f = 6.3\text{V}$, $I_f = 0.9\text{A}$	<p>Guitarist's Opinion: This "black plate" tube has a lot of grit in overdrive. It's bright, focused and chimey.</p>	 T-6L6GC-TAD Seated Height = 3.71" Glass Diameter = 1.49"
6L6WGC Tube Amp Doctor Made in China Maximum Ratings $V_a = 550\text{V}$ $V_{g2} = 450\text{V}$ $W_a = 30\text{W}$ Filament $V_f = 6.3\text{V}$, $I_f = 0.9\text{A}$	<p>Guitarist's Opinion: 6L6WGC "black plate" is slightly smoother than TAD 6L6GC with reduced bite and brightness.</p>	 T-6L6WGC-TAD Seated Height = 3.09" Glass Diameter = 1.50"

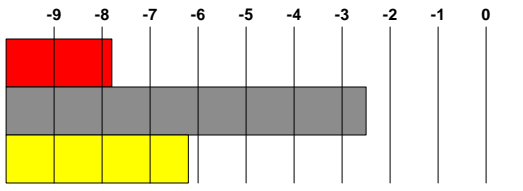
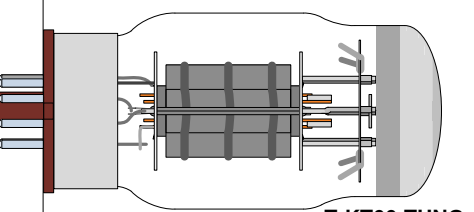
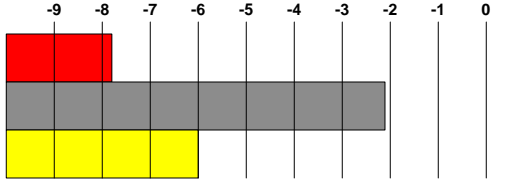
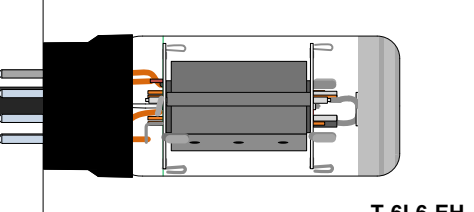
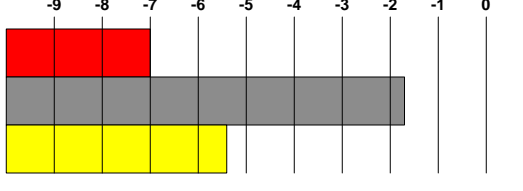
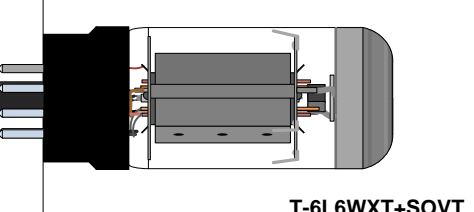
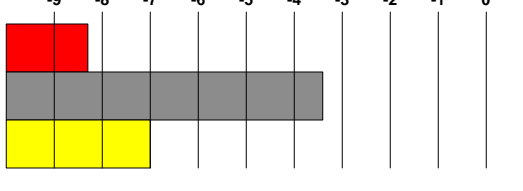
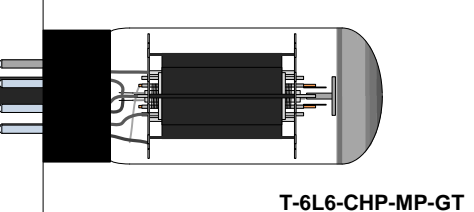
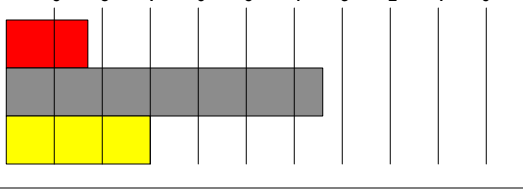
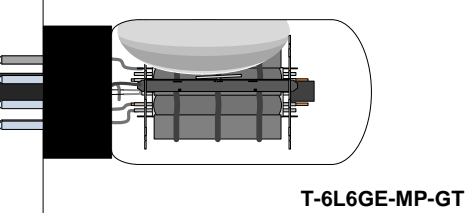
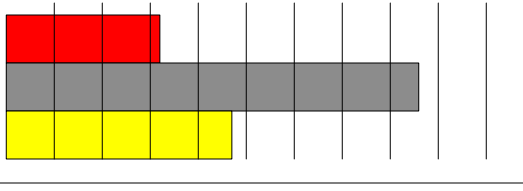
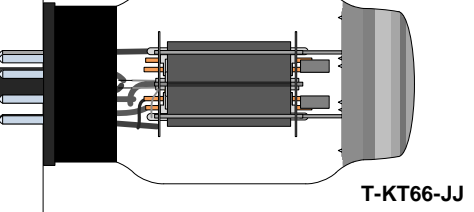
Tube Brand / Electrical Ratings	Measured Voltage Gain (dB)	Physical Comparison
<p>KT66 Tung-Sol Reissue Made in Russia Maximum Ratings Va = 500V Vg2 = 450V Wa = 30W Filament Vf = 6.3V, If = 0.9A</p>	 <p>Guitarist's Opinion: This big bottle tube is tight, smooth and punchy. It offers a lot of sizzle for overdrive leads.</p>	 <p>T-KT66-TUNG Seated Height = 4.07" Glass Diameter = 2.03"</p>
<p>6L6GC Electro-Harmonix Made in Russia Maximum Ratings Va = 500V Vg2 = 450V Wa = 30W Filament Vf = 6.3V, If = 0.9A</p>	 <p>Guitarist's Opinion: This tube has a straightforward tone that's strong and tight with a chimey top-end.</p>	 <p>T-6L6-EH Seated Height = 3.68" Glass Diameter = 1.46"</p>
<p>6L6WXT+ Sovtek Made in Russia Maximum Ratings Va = 500V Vg2 = 450V Wa = 30W Filament Vf = 6.3V, If = 0.9A</p>	 <p>Guitarist's Opinion: This tube is similar to its EH cousin, but with a little more warmth and low-end.</p>	 <p>T-6L6WXT+SOVT Seated Height = 3.63" Glass Diameter = 1.47"</p>
<p>6L6-CHP Groove Tubes Made in China Maximum Ratings Va = 500V Vg2 = 450V Wa = 30W Filament Vf = 6.3V, If = 0.9A</p>	 <p>Guitarist's Opinion: This "black plate" tube is focused and tight with crisp, chimey highs.</p>	 <p>T-6L6-CHP-MP-GT Seated Height = 3.53" Glass Diameter = 1.39"</p>
<p>6L6-GE Groove Tubes Made in China Maximum Ratings Va = 500V Vg2 = 450V Wa = 30W Filament Vf = 6.3V, If = 0.9A</p>	 <p>Guitarist's Opinion: This reproduction of a GE "cleartop" is similar to the CHP, but smoother and sweeter in the highs.</p>	 <p>T-6L6GE-MP-GT Seated Height = 3.44" Glass Diameter = 1.50"</p>
<p>KT66 JJ Electronic Made in Slovakia Maximum Ratings Va = 550V Vg2 = 550V Wa = 25W Filament Vf = 6.3V, If = 1.3A</p>	 <p>Guitarist's Opinion: This tube is tight, smooth, crisp and punchy with bigger lows than other KT66's.</p>	 <p>T-KT66-JJ Seated Height = 3.92" Glass Diameter = 2.50"</p>

Tube Brand / Electrical Ratings	Measured Voltage Gain (dB)	Physical Comparison
<p>6L6WGC China Made in China Maximum Ratings Va = 400V Vg2 = 400V Wa = 25W Filament Vf = 6.3V, If = 0.9A</p>		
<p>Guitarist's Opinion: This "black plate" tube is focused, loose and easy on the highs.</p>	<p>T-6L6WGC-SINO Seated Height = 3.69" Glass Diameter = 1.47"</p>	
<p>5881WXT Sovtek Made in Russia Maximum Ratings Va = 500V Vg2 = 450V Wa = 23.5W Filament Vf = 6.3V, If = 0.9A</p>		
<p>Guitarist's Opinion: This tube is similar to its EH cousin, having a focused, straightforward tone.</p>	<p>T-5881WXT-SOVT Seated Height = 3.65" Glass Diameter = 1.45"</p>	
<p>5881 Sovtek Made in Russia Maximum Ratings Va = 500V Vg2 = 450V Wa = 23.5W Filament Vf = 6.3V, If = 0.9A</p>		
<p>Guitarist's Opinion: This tube is the same 5881WXT, but with a smaller "wafer" base.</p>	<p>T-5881-SOVT Seated Height = 3.38" Glass Diameter = 1.46"</p>	
<p>6L6WGS China Made in China Maximum Ratings Va = 400V Vg2 = 400V Wa = 23W Filament Vf = 6.3V, If = 0.9A</p>		
<p>Guitarist's Opinion: This "black plate" tube is warm, fat and loose with a smooth top-end.</p>	<p>T-6L6WGS-SINO Seated Height = 3.15" Glass Diameter = 1.52"</p>	
<p>5881 Tung-Sol Reissue Made in Russia Maximum Ratings Va = 400V Vg2 = 400V Wa = 23W Filament Vf = 6.3V, If = 0.9A</p>		
<p>Guitarist's Opinion: This tube is focused and bright with top-end sparkle.</p>	<p>T-5881-TUNG Seated Height = 2.91" Glass Diameter = 1.45"</p>	

A Comparison of Current Production 6L6GC Tubes by Kurt Prange

RCA introduced the 6L6 to the world in the 1930's. It had a metal envelope which was popular at that time for use in radio sets since it was less likely to break than a glass envelope. Revisions to the original metal 6L6 such as increased power handling and glass envelopes yielded new designations such as 6L6G, 6L6GA, 6L6GB and finally 6L6GC (introduced by GE in the late 1950's). Today, the 6L6GC is one of the most common power tubes used for electric guitar amplification and there is an almost overwhelming supply of current production options to choose from. The purpose of this comparison is simply to provide guitar players with a frame of reference to help in finding the best current production 6L6GC for their needs.

Also included in this comparison are direct substitutes for the 6L6GC including: KT66 and 5881.

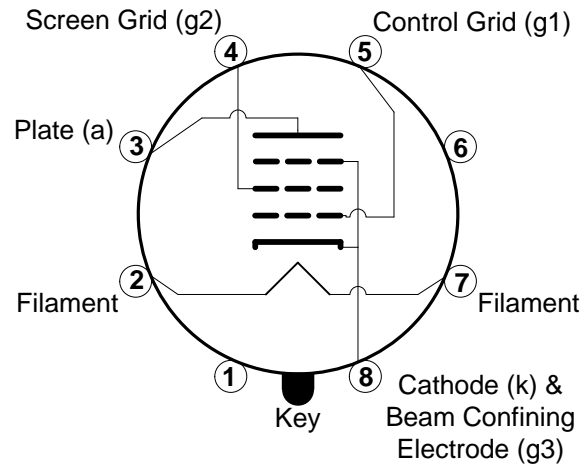
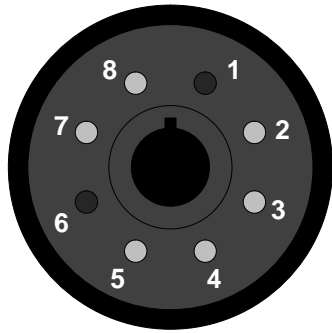

BASING DIAGRAM

6L6GC Basics

The 6L6GC is an octal, beam power tube. What does that mean? The **octal** part tells us what kind of socket the tube plugs into. It has eight pins arranged around the circumference of a circle with a diameter of about 11/16 of an inch. There is a key between pins 1 and 8 to ensure that the tube can only be plugged in one way.

The **beam power** part tells us that the tube, as RCA put it, "is a tetrode or pentode in which directed electron beams are used to increase substantially the power-handling capability of the tube. A feature of a beam power tube is its low screen-grid current. Because of the effective suppressor action provided by space charge and because of the low current drawn by the screen grid, the beam power tube has the advantages of high power output, high power sensitivity, and high efficiency." The 6L6GC is a type of beam power tube employing a beam-confining electrode at cathode potential in place of an actual suppressor grid.

The Measured Voltage Gain Test Setup

Each tube sample was installed in the same custom built, fixed bias single-ended guitar amplifier (see schematic) with a Fender black face style preamp circuit. A frequency generator was used to measure voltage gain and plot the frequency response from 10Hz to 20kHz. The input voltage was measured at the 6L6GC control grid (g1) and the output voltage was measured at the output transformer's secondary winding while connected to an 8 ohm load.

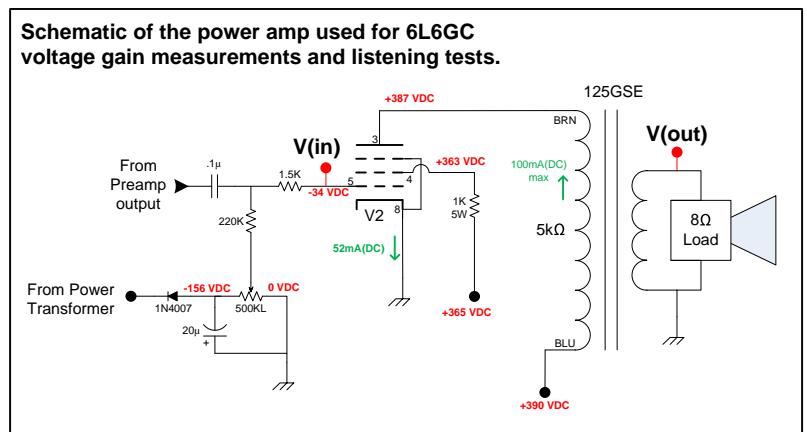

Three frequencies were chosen from the frequency plots to represent the lows, mids and highs: 50Hz, 700Hz and 6kHz, respectively, for each tube brand (for a quicker visual reference). Each tube sample used for comparison was chosen because it measured in the middle range of idle plate current draw at the same operating point set by a Maxi-Matcher Digital Tube Tester: $V_a = 400\text{VDC}$, $V_{g1} = -48\text{VDC}$, $I_a \approx 24\text{mA}$.

Frequency Sweep of Current Production 6L6GC's

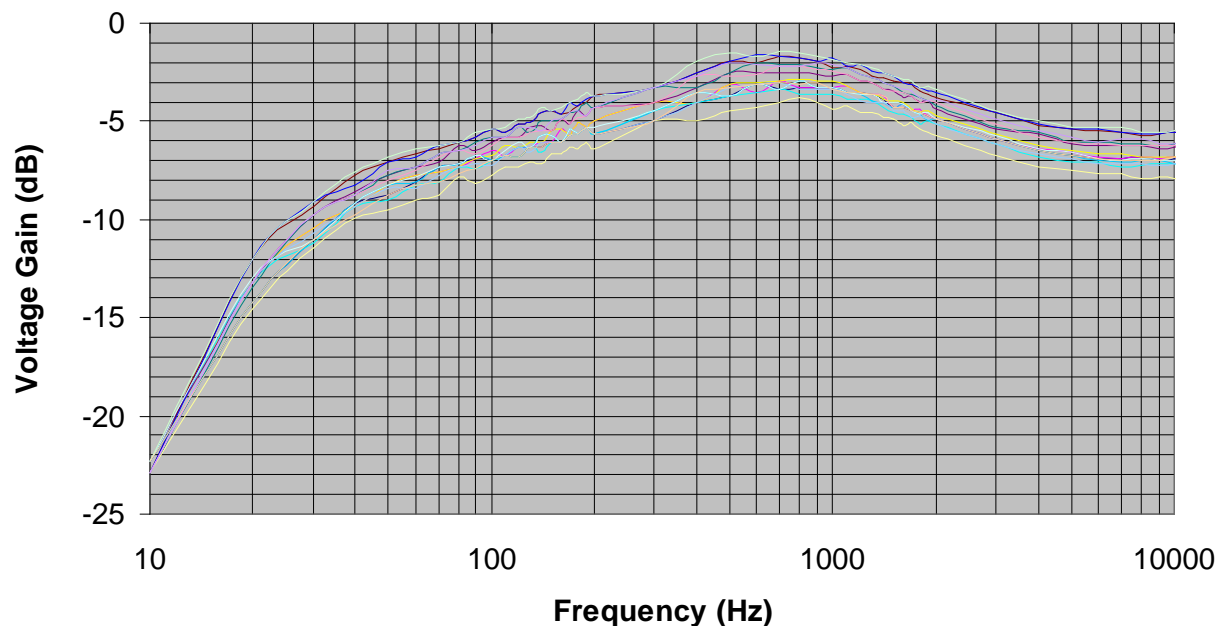

The Listening Test Setup

A custom 6L6GC switching box was constructed to allow for a quick switch comparison of two tubes at a time while plugged into the V2 socket of the same fixed bias, single-ended guitar amplifier used for the frequency sweep. Listening tests were then conducted while playing guitar and switching between the tubes at various amplifier control settings to come up with "guitarist's opinion" descriptions for each tube.

Kurt Prange (BSEE) is the Sales Engineer for Amplified Parts (www.amplifiedparts.com) in Tempe, Arizona, United States. Kurt began playing guitar at the age of nine in Kalamazoo, Michigan. He is a guitar DIY'er and tube amp designer who enjoys helping other musicians along in the endless pursuit of tone.