

DIMENSIONS:	
A	3.750" ±0.063
B	4.188" ±0.125
C	4.563" ±0.063
D	3.000" ±0.063
E	3.063" ±0.063
G	0.203" x 0.375" ±0.015

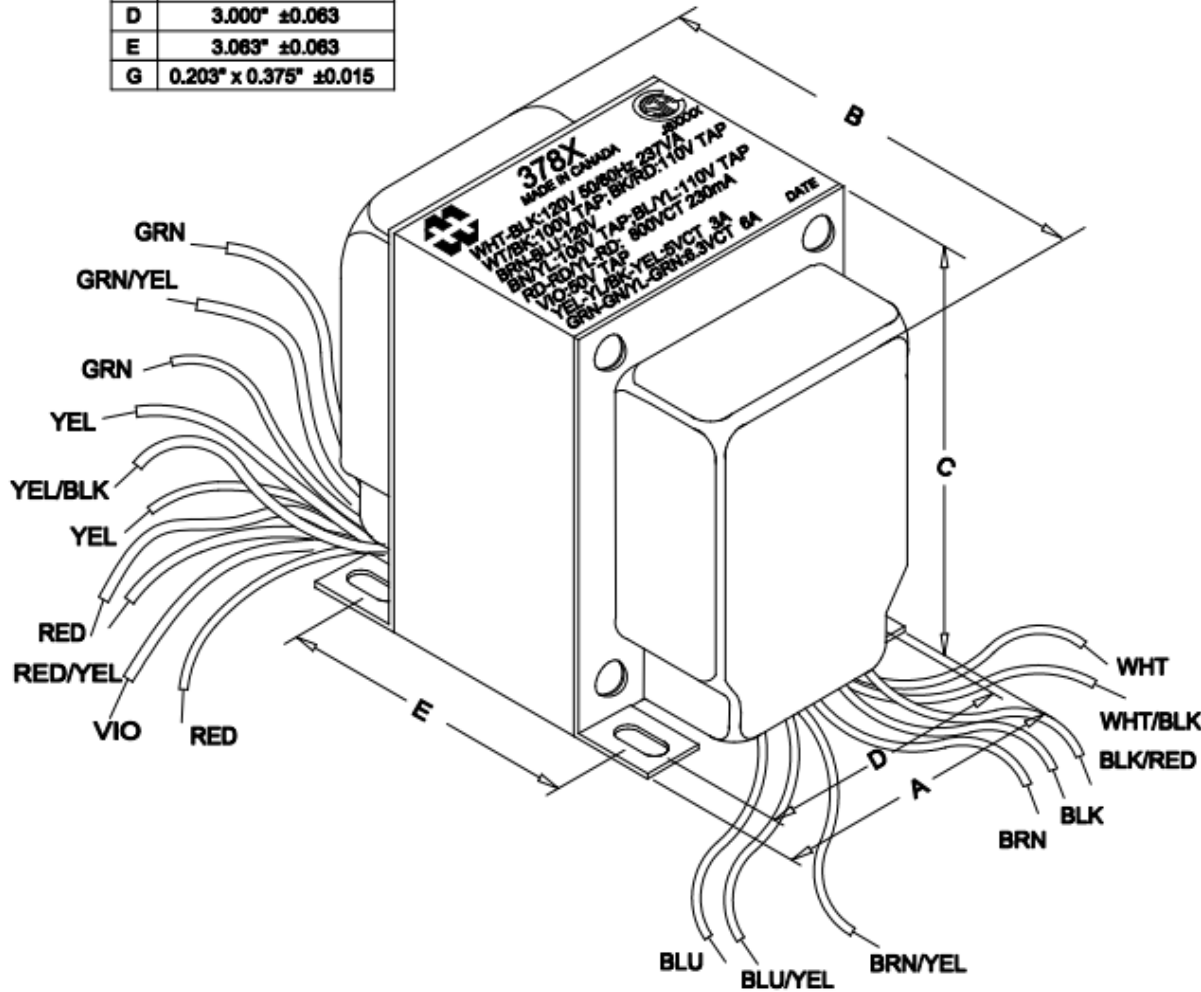

NOTE: ALL LEADS 8" OUT MIN., STRIPPED .5"

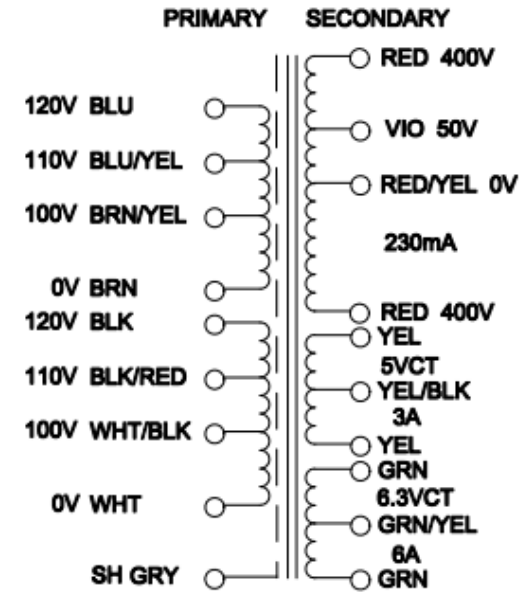

ELECTRICAL DATA:		
TESTS	CONDITIONS	ACCEPTANCE CRITERIA
I _{ex}	@ 120V, 60Hz, WHT - BLK	70mA Max.
Sec. N.L.V	@ 120V, 60Hz, WHT - BLK	
	RED - RED =	845.8V ±2%
	RED - RED/YEL = RED/YEL - RED =	422.9V ±2%
	RED/YEL - VIO =	52.13V ±2%
	YEL - YEL =	5.383V ±2%
	YEL - YEL/BLK = YEL/BLK - YEL =	2.897V ±2%
	GRN - GRN =	6.742V ±2%
	GRN - GRN/YEL = GRN/YEL - GRN =	3.371V ±2%
DCR	@ 20°C, WHT - BLK =	2.671 Ω ±20%
	@ 20°C, BRN - BLU =	2.911 Ω ±20%
	@ 20°C, RED - RED =	92.81 Ω ±20%
	@ 20°C, YEL - YEL =	0.062 Ω ±20%
	@ 20°C, GRN - GRN =	0.041 Ω ±20%
HIPOT	PRIMARY - SECONDARY	2500V, 60Hz, 1 SEC