

BIPOLAR ANALOG INTEGRATED CIRCUIT

μ PC1188H

20 W AUDIO POWER AMPLIFIER

DESCRIPTION

The μ PC1188H is a monolithic integrated circuit and a power amplifier designed for Hi-Fi audio sets and in a 10pin Single In-Line plastic package. μ PC1188H can provide 20 W (TYP.) to 8 ohms at 1 % T.H.D. and ± 22 V Supply voltage.

FEATURES

- High output power. 20 W TYP. ($V_{CC} = \pm 22$ V, $A_V = 40$ dB, $f = 20$ Hz ~ 20 kHz, $R_L = 8 \Omega$, T.H.D. = 1 %)
 - 20 W TYP. ($V_{CC} = \pm 22$ V, $A_V = 27.5$ dB, $f = 20$ Hz ~ 20 kHz, $R_L = 8 \Omega$, T.H.D. = 0.5 %)
- Low distortion. 0.02 % TYP. ($V_{CC} = \pm 22$ V, $A_V = 40$ dB, $f = 1$ kHz, $R_L = 8 \Omega$, $P_{out} = 5.0$ W)
 - 0.005 % TYP. ($V_{CC} = \pm 22$ V, $A_V = 27.5$ dB, $f = 1$ kHz, $R_L = 8 \Omega$, $P_{out} = 5.0$ W)
- Wide frequency band width. $f = 250$ kHz (-3 dB)
- μ PC1188H has a muting function which eliminates pop on noise and the thermal and the over current protection circuit.
- Available for NFB tone control amp.

BLOCK DIAGRAM

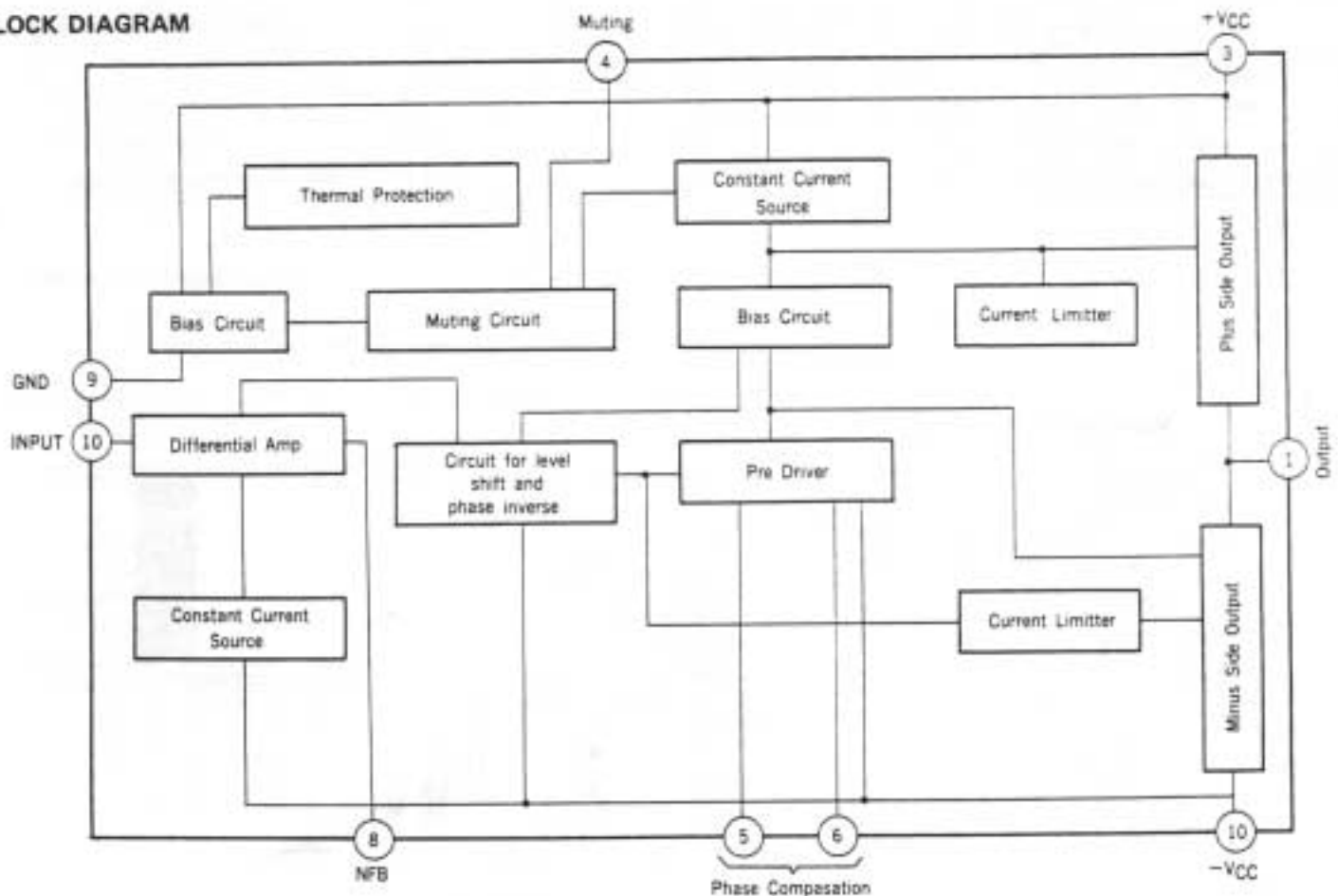

ABSOLUTE MAXIMUM RATINGS (Ta = 25 °C)

Supply Voltage (Quiescent)	V _{CC}	± 30	V
Circuit Current	I _{CC(peak)}	5	A
Package Dissipation	P _D	30*	W
Operating Temperature	T _{opt}	-20 to +70	°C
Storage Temperature	T _{stg}	-55 to +150	°C
Thermal Resistance Junction to Case	R _{th(j-c)}	3	°C/W

* T_{tab} = 60 °C

RECOMMENDED OPERATING CONDITIONS (Ta = 25 °C)

CHARACTERISTIC	MIN.	TYP.	MAX.	UNIT
Operating Supply Voltage	± 17	± 22	± 23	V
Input Impedance	47	56	100	kΩ
Closed Loop Voltage Gain	26	40		dB
Load Impedance	4	8		Ω

ELECTRIC CHARACTERISTICS (V_{CC} = ±22 V, A_V = 40 dB, R_L = 8 Ω, R_G = 600 Ω, Ta = 25 °C)

CHARACTERISTIC	SYMBOL	MIN.	TYP.	MAX.	UNIT	TEST CONDITIONS
Output Offset Voltage	V _{IO}	-100	0	+100	mV	No Signal
Circuit Current	I _{CC}	30	60	120	mA	No Signal
Output Power	P _O	16	18		W	T.H.D. = 0.5 %, f = 20 Hz - 20 kHz
Open Loop Voltage Gain	A _{vo}	66	75		dB	P _O = 0.3 W, f = 1 kHz
Total Harmonic Distortion	T.H.D.		0.1	0.3	%	P _O = 10 W, f = 20 Hz - 20 kHz
Output Noise Voltage	NV		0.4	1.0	mV	R _G = 2.2 kΩ, No Filter
Power Band Width	P.B.W.		250		kHz	P _O = 0.3 W, -3 dB
Supply Voltage Rejection Ratio	S.V.R.	50	56		dB	R _G = 2.2 kΩ, fripple = 100 Hz

PACKAGE DIMENSION

Unit: mm

Typical value unless otherwise noted

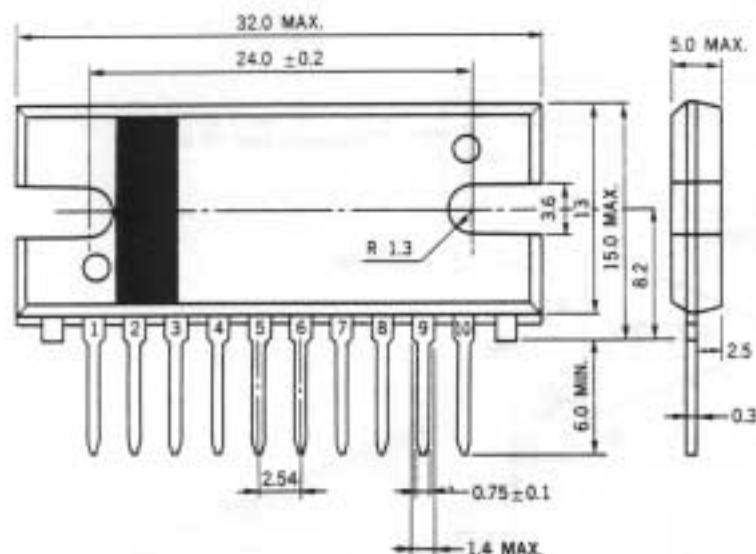

CONNECTION DIAGRAM

1	OUTPUT
2	NC
3	+V _{CC}
4	MUTING
5	PHASE COMP
6	PHASE COMP
7	INPUT
8	NFB
9	GND
10	-V _{CC}

TEST CIRCUIT

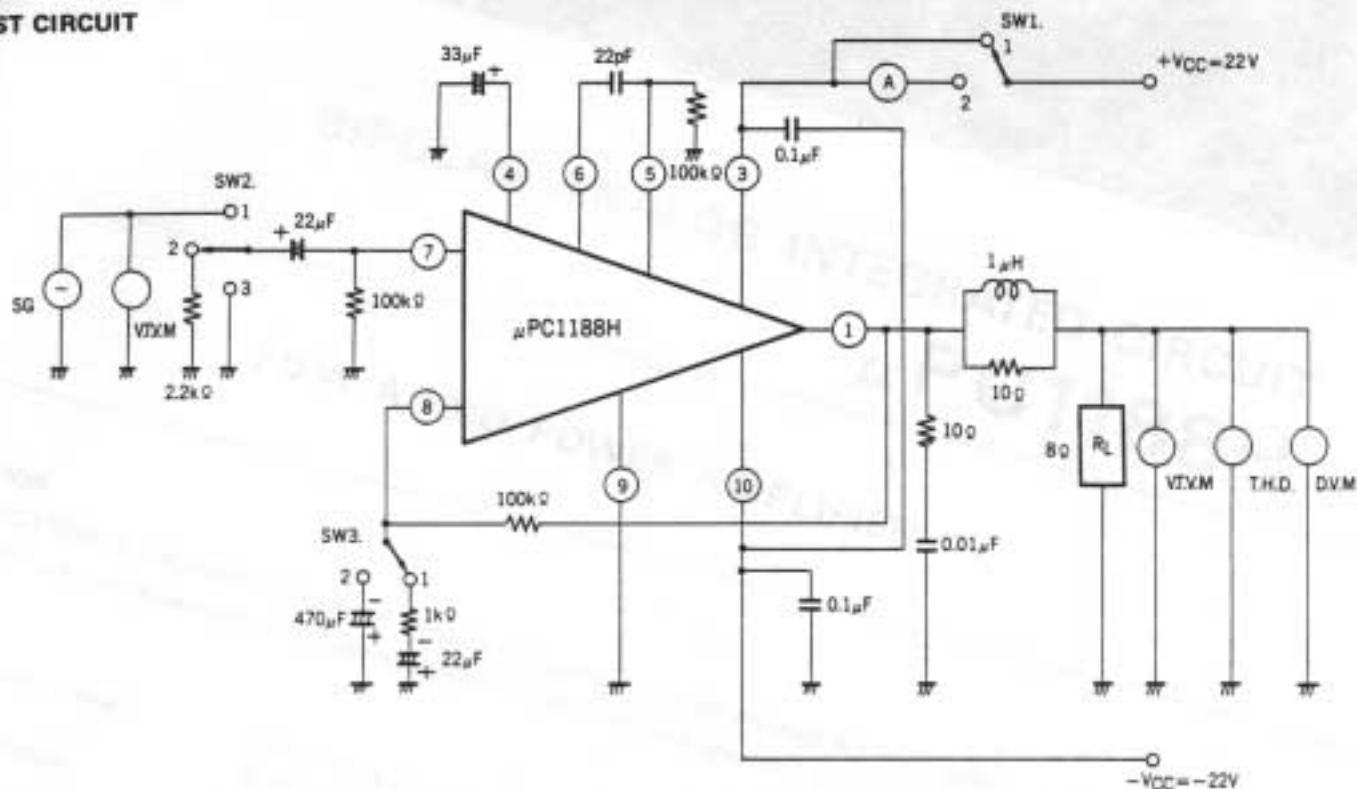

NOTE: Turn on plus and minus power supply at the same time or minus power supply at first.

ITEM	SYMBOL	SW1	SW2	SW3
Circuit Current	I_{CC}	2	3	1
Output Offset Voltage	V_{IO}	1	3	1
Output Power	P_O	1	1	1
Open Loop Voltage Gain	A_{VO}	1	1	2
Total Harmonic Distortion	T.H.D.	1	1	1
Output Noise Voltage	NV	1	2	1
Supply Voltage Rejection Ratio	SVR	1	2	1

APPLICATION CIRCUIT

