

DUAL OPERATIONAL AMPLIFIER

■ GENERAL DESCRIPTION

The NJM4558/4559 integrated circuit is a dual high-gain operational amplifier internally compensated and constructed on a single silicon chip using an advanced epitaxial process.

Combining the features of the NJM741 with the close parameter matching and tracking of a dual device on a monolithic chip results in unique performance characteristics. Excellent channel separation allows the use of the dual device in single NJM741 operational amplifier applications providing density. It is especially well suited for applications in differential-in, differential-out as well as in potentiometric amplifiers and where gain and phase matched channels are mandatory.

■ FEATURES

- Operating Voltage ($\pm 4V \sim \pm 18V$)
- High Voltage Gain (100dB typ.)
- High Input Resistance ($5M\Omega$ typ.)
- Bipolar Technology
- Package Outline
 DIP8, DMP8, SIP8
 SOP8 JEDEC 150mil (only NJM4558),
 SSOP8 (only NJM4558)

■ PACKAGE OUTLINE



**NJM4558D
NJM4559D
(DIP8)**



**NJM4558M
NJM4559M
(DMP8)**



**NJM4558V
(SSOP8)**

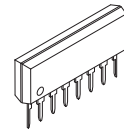

**NJM4558L
NJM4559L
(SIP8)**



**NJM4558E
(SOP8)**

■ PIN CONFIGURATION

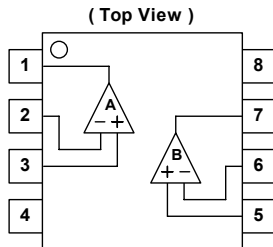

**NJM4558D, NJM4558M, NJM4558E, NJM4558V
NJM4559D, NJM4559M**

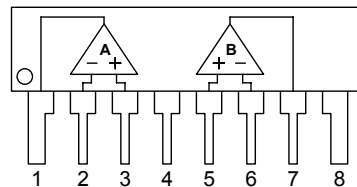

**NJM4558L
NJM4559L**

PIN FUNCTION

1. A OUTPUT
2. A - INPUT
3. A + INPUT
4. V^-
5. B + INPUT
6. B - INPUT
7. B OUTPUT

■ EQUIVALENT CIRCUIT (1/2 Shown)

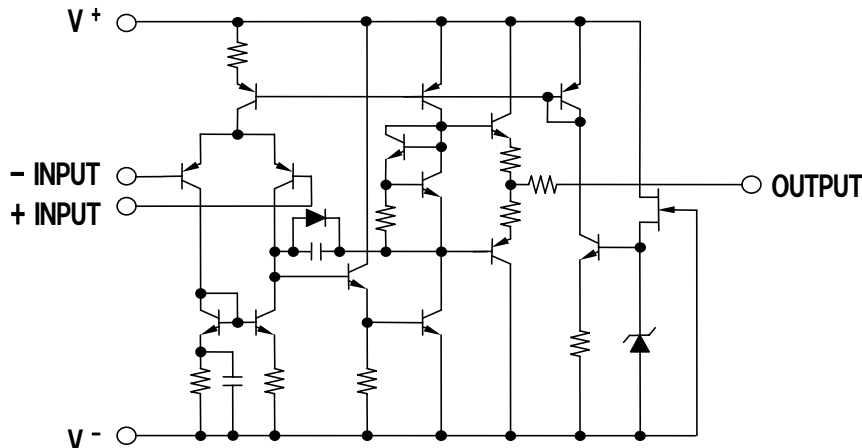

NJM4558/4559

■ ABSOLUTE MAXIMUM RATINGS

(Ta=25°C)

PARAMETER	SYMBOL	RATINGS	UNIT
Supply Voltage	V^+V^-	± 18	V
Differential Input Voltage	V_{ID}	± 30	V
Input Voltage	V_{IC}	± 15 (note1)	V
Power Dissipation	P_D	(DIP8) 500 (DMP8) 300 (SOP8) 300 (SSOP8) 250 (SIP8) 800	mW
Operating Temperature Range	T_{opr}	-40~+85	°C
Storage Temperature Range	T_{stg}	-40~+125	°C

(note1) For supply voltage less than ±15V, the absolute maximum input voltage is equal to the supply voltage.

■ ELECTRICAL CHARACTERISTICS

(V^+V^- =±15V, Ta=25°C)

PARAMETER	SYMBOL	TEST CONDITION	MIN.	TYP.	MAX.	UNIT
Input Offset Voltage	V_{IO}	$R_S \leq 10k\Omega$	-	0.5	6	mV
Input Offset Current	I_{IO}		-	5	200	nA
Input Bias Current	I_B		-	25	500	nA
Input Resistance	R_{IN}		0.3	5	-	MΩ
Large Signal Voltage Gain	A_V	$R_L \geq 2k\Omega, V_O = \pm 10V$	86	100	-	dB
Maximum Output Voltage Swing 1	V_{OM1}	$R_L \geq 10k\Omega$	± 12	± 14	-	V
Maximum Output Voltage Swing 2	V_{OM2}	$R_L \geq 2k\Omega$	± 10	± 13	-	V
Input Common Mode Voltage Range	V_{ICM}		± 12	14	-	V
Common Mode Rejection Ratio	CMR	$R_S \leq 10k\Omega$	70	90	-	dB
Supply Voltage Rejection Ratio	SVR	$R_S \leq 10k\Omega$	76.5	90	-	dB
Operating Current	I_{CC}		-	3.5	5.7	mA
Slew Rate						
NJM4558	SR		-	1	-	V/μs
NJM4559	SR		-	2	-	V/μs
Equivalent Input Noise Voltage (note2)	V_{NI}	RIAA, $R_S = 2.2k\Omega$, 30kHz LPF	-	1.4	-	μVrms
Gain Bandwidth Product	GB					
NJM4558				3		MHz
NJM4559				6		MHz

(note2) In regard to Noise Standard, NJRC is preparing for special D Rank type products ($V_{NI} = 1.8\mu V$ max.) except for SSOP package.

■ TYPICAL CHARACTERISTICS

Open Loop Voltage Gain vs. Frequency

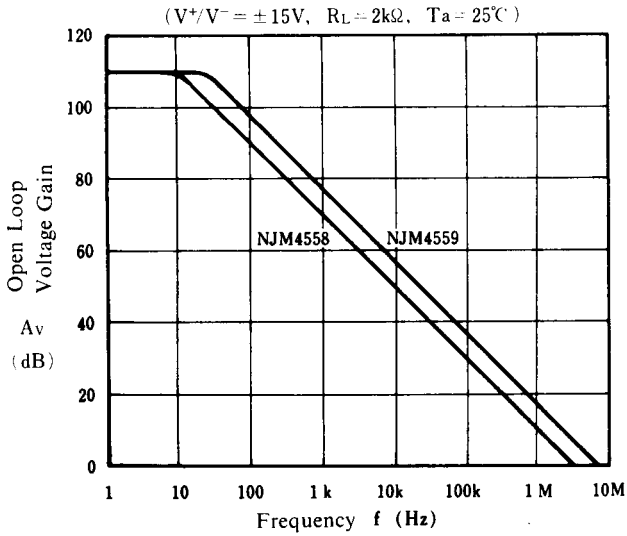

Maximum Output Voltage Swing vs. Frequency

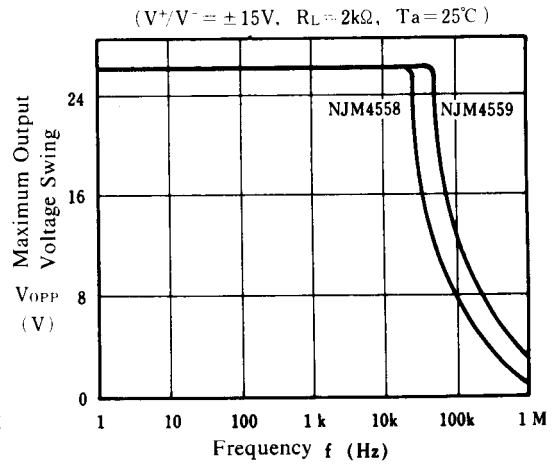

Maximum Output Voltage Swing vs. Load Resistance

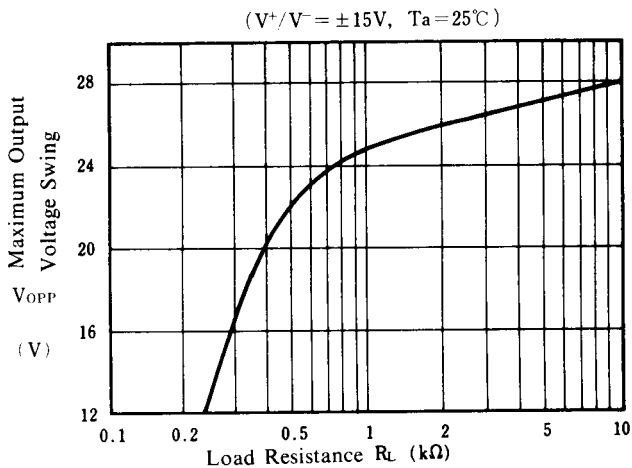

Equivalent Input Noise Voltage vs. Frequency

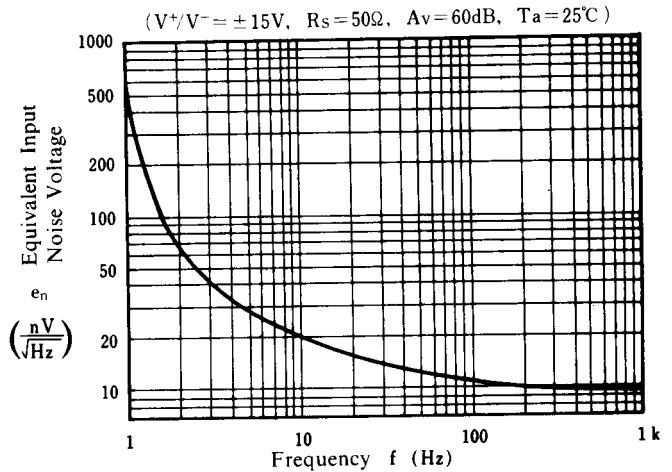

Operating Current vs. Temperature

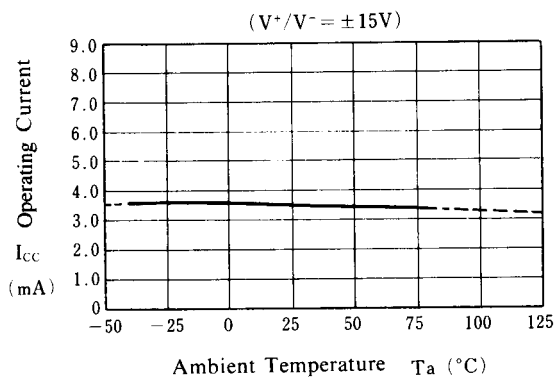

Maximum Output Voltage Swing vs. Temperature

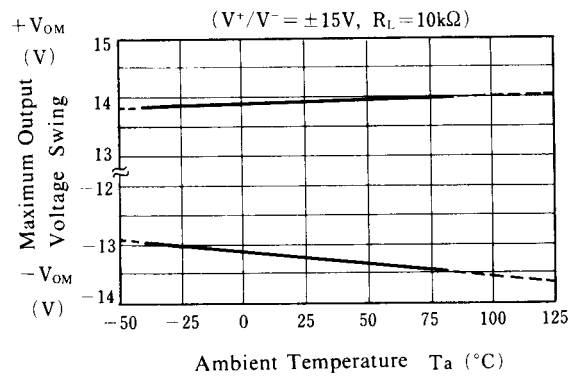

NJM4558/4559

■ TYPICAL CHARACTERISTICS

Input Offset Voltage vs. Temperature

($V^+/V^- = \pm 15V$)

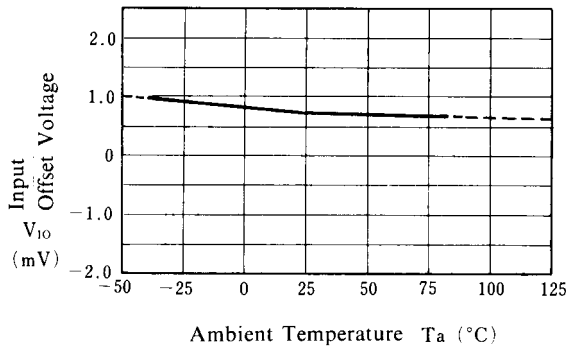

Input Bias Current vs. Temperature

($V^+/V^- = \pm 15V$)

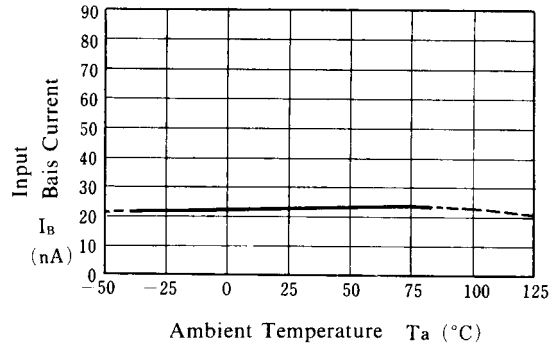

Maximum Output Voltage Swing vs. Operating Voltage

($R_L = 2k\Omega$, $T_a = 25^\circ C$)

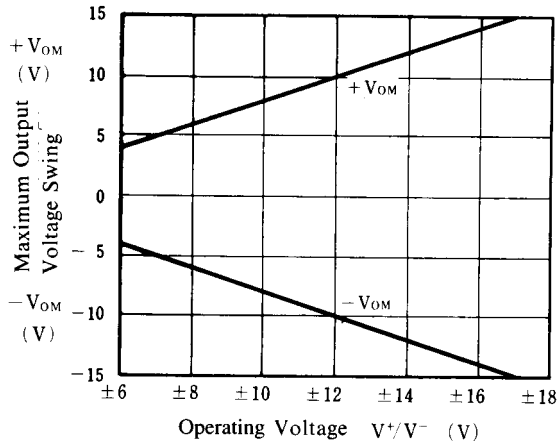

Operating Current vs. Operating Voltage

($T_a = 25^\circ C$)

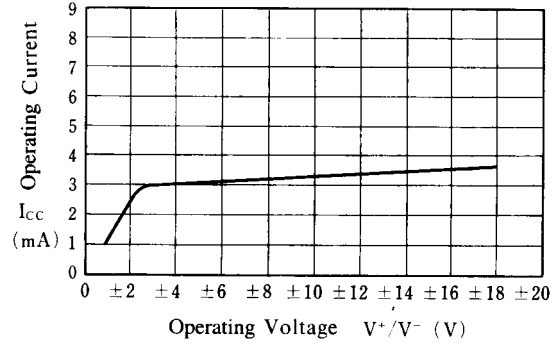

[CAUTION]

The specifications on this databook are only given for information, without any guarantee as regards either mistakes or omissions. The application circuits in this databook are described only to show representative usages of the product and not intended for the guarantee or permission of any right including the industrial rights.