

# MOD102 to MOD102+ Conversion - Parts List Drawings

## 1. Input grid-stop resistor mod

R-A33K (1) 33kΩ, ½W resistor

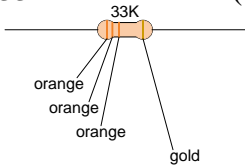

## 2. Push-pull mod

R-VC1MA-PP (1) 1MΩ push-pull pot (SPST)

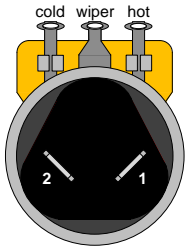

R-VB2-250KAPPSS (2)  
250kΩ push-pull pot (DPDT)

Symbol used in the layout drawings to show the switch and potentiometer terminal connections simultaneously.

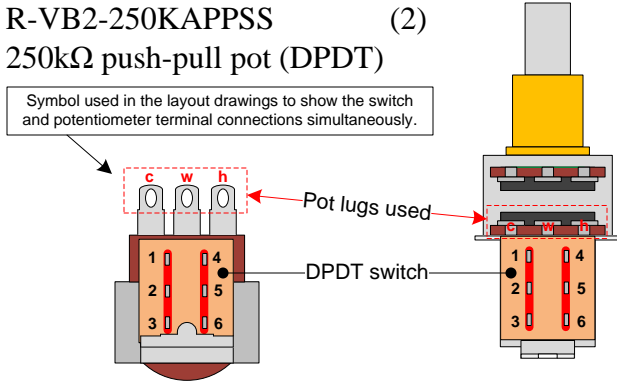

S-HLW38 (3) 3/8" lock washer

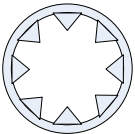

R-A10K (1) 10kΩ, ½W resistor

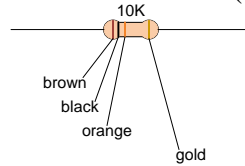

C-TD047-400 (1) 0.047μF capacitor

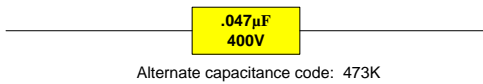

C-SM150 (1) 150pF capacitor

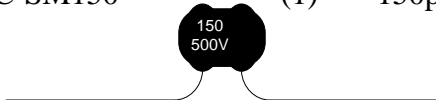

## 3. Power tube screen and cathode resistor mod

R-B470 (1) 470Ω, 1W resistor

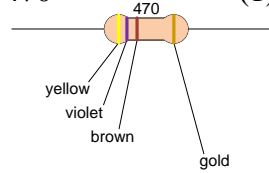

R-Q150 (1) 150Ω, 5W resistor

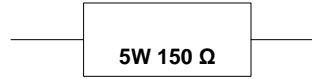

## 4. Filter section upgrade mod

C-ET47-350 (2) 47μF polarized capacitor

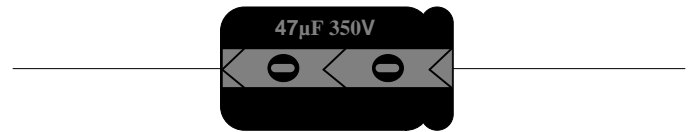

R-B10K (1) 10kΩ, 1W resistor

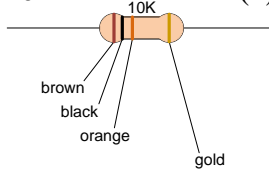

## 5. Alternate filament hum reduction mod (two 100 ohm resistor method)

R-B100 (2) 100Ω, 1W resistor

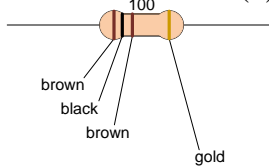

## 6. Power/standby switch and bleed resistor mod

R-A470K (1) 470KΩ, ½W resistor

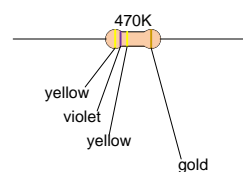

P-H520 (1) power/standby switch

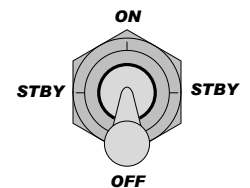
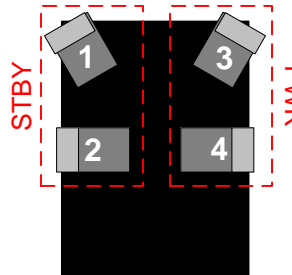

## Modifying your MOD 102 with the features of the MOD 102+

Modifying your MOD102 with the features of the MOD102+ shouldn't require drilling new chassis holes, unless you have already used the open terminals T1(2) and T1(4) for something else. (In that case, you will want to add a terminal strip with at least two un-grounded terminals for the power/standby switch mod).

The 102+ modifications include:

1. Input grid-stop resistor
2. Push-pull
3. Modified power tube screen and cathode resistors
4. Filter section upgrade
5. Alternate filament hum reduction (two 100 ohm resistor method)
6. Power/standby switch and bleed resistor

**Warning:** Before working on the amp, always make sure it is unplugged, powered off and the filter caps have been drained of voltage.

See the last page for a MOD 102+ Layout Drawing and schematic.

### 1. Input grid-stop resistor mod

Adding this resistor makes the preamp less susceptible to radio interference.

- Remove the wire connecting the input jack's tip lug to V1 pin 2.
- Replace it with a 33K resistor.

### 2. Push-pull mod

- Disconnect the 6.8K resistor from the Bass pot and T3 terminal strip and set it aside for now.
- Disconnect the .047 $\mu$ F and .1 $\mu$ F caps from the bass pot.
- Disconnect the 250pF cap from the treble pot.
- Disconnect the V1 pin 7 wire from the volume pot.
- Disconnect the input jack's sleeve wire from the volume pot.
- Remove the original bass, treble and volume pots from the amp.

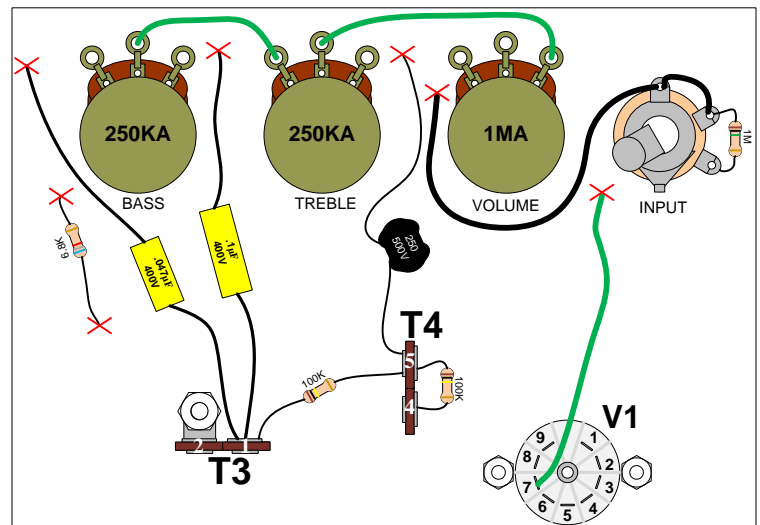

#### Mount the New Push-Pull Treble and Bass Pots:

- Remove the two nuts and two flat washers from the 250K Bass and Treble pot bushings. On each pot put one nut on the bushing, turning it all the way down on the bushing.
- Put one of the 3/8" lock washers on the bushing, then mount the pot to the front panel with all lugs facing up.
- Place one of the flat washers on the bushing followed by the remaining mounting nut and tighten. (Keep the remaining flat washers as one will be used in the next step).

#### Mount the New Push-Pull Volume Pot:

- Remove the nut from the bushing leaving the black lock washer on the bushing.
- Bend back the small mounting tab on the side of this pot so that it does not interfere with mounting.
- Put one of the 3/8" lock washers on the bushing and mount the pot to the front panel with its solder lugs facing up.

Bend back mounting tab

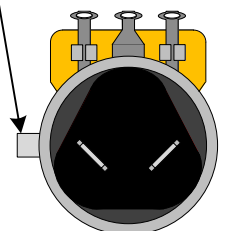

- Put one of the flat washers from the previous step on the bushing followed by the nut, and tighten.

### Connect the T3 and bass pot components:

The bass and treble controls are dual 250K pots with a DPDT push-pull switch attached. The front pot section, closest to the front panel, will not be used. The DPDT lug numbering is shown in the drawing here.

- Connect the previously removed 6.8K resistor from the bass pot's c-lug ("cold" lug) to mid-boost switch lug 2, but **do not solder either connection point, yet.**

*Tip: When making the capacitor connections at this pot, it is important that the leads do not accidentally touch the pot/switch body or a different lug than intended. If you feel it is necessary to insulate the capacitor leads, you might consider doing so by stripping some of the insulation from some 22 AWG wire and sliding it over the capacitor leads.*

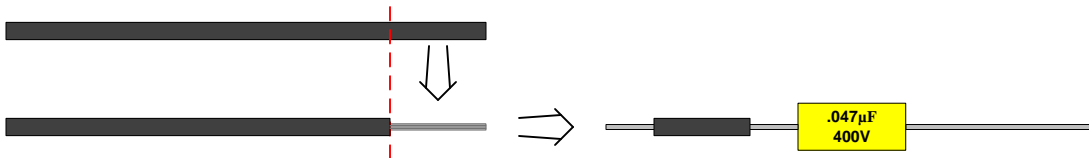
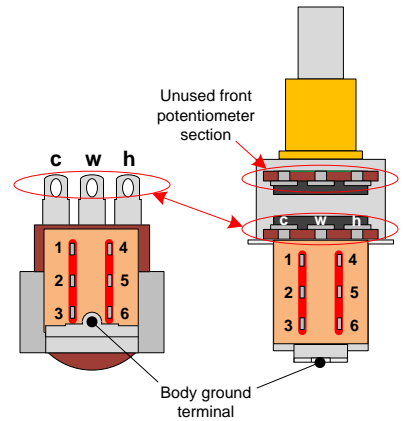

- Connect the .047 µF cap from T3(1) to the bass pot's c-lug. Now, solder these connections.
- Connect one lead of a 10K, ½ watt resistor to mid-boost switch lug 2 and connect the other lead to both mid-boost switch lug 3 and the body ground terminal. Now, solder these connections.
- Connect the .1 µF cap from T3(1) to the bass pot's w-lug ("wiper" lug), but **do not solder at the w-lug, yet.**
- Connect a 2" piece of wire from the bass pot's w-lug to the treble pot's c-lug. Now, solder these connections.

### Connect the treble pot components:

- Connect a 2 ¾" piece of wire from the treble pot's w-lug to the volume pot's "hot" lug. **Do not solder these connections, yet.**
- Connect a 150 pF capacitor from the treble pot's w-lug to bright switch lug 4. Solder the treble pot connection now.
- Connect the 250 pF capacitor from T4(5) to the treble pot's h-lug.

### Connect the volume pot:

- Connect a 2" piece of wire from bright switch lug 5 to the volume pot's wiper lug. **Do not solder the wiper lug connection, yet.**

*Tip: Normally, it's a good idea to strip and tin ¼" at the stranded wire ends before making the connections. In this case, on the end that will connect to the switch lug, just strip 1/8" and do not tin that end.*



- Connect the wire from the input jack's sleeve lug to the volume pot's cold lug.
- Connect a 1 ½" piece of wire from the volume pot's hot lug to turbo switch lug 1. Solder the volume pot connections.
- Connect the V1 pin 7 wire to the volume pot's wiper lug. **Solder all connections, now.**
- Connect a .047 µF cap from T4(5) to turbo switch lug 2.

## 3. Power tube screen and cathode resistor mod

- Replace the 1K resistor from V2 pin 9 to T6(5) with a 470 ohm 1W resistor.
- Replace the 200 ohm resistor from V2 pin 3 to T6(1) with a 150 ohm 5W resistor.

#### 4. Filter section upgrade mod

- Remove the two 22 $\mu$ F @ 350V filter caps and replace them with 47 $\mu$ F @ 350V caps.
- Remove the 22K 1W resistor from T2(3) to T2(2) and replace it with a 10K 1W resistor.

#### 5. Alternate filament hum reduction mod (two 100 ohm resistor method)

- Remove the connection between V2 pins 3 and 4.

##### Mount the two 100 $\Omega$ filament resistors to T1:

- Connect a 100  $\Omega$  resistor from one of the lamp holder solder lugs to its most convenient ground terminal on T1.
- Connect another 100  $\Omega$  resistor from the other lamp holder solder lug to its most convenient ground terminal on T1.

#### 6. Power/standby switch and bleed resistor mod

- Remove both wires from the original SPST power switch and remove it from the amp.
- Mount the new 3 position progressive DPST toggle switch in the power switch slot. Mount it with its solder lugs directed toward the chassis box opening if you want the "PLAY" setting to correspond with flipping the switch upward.
- Disconnect the 100  $\Omega$  resistor from T2 and connect it to T1(4) and T1(2) instead.
- Connect a 470K resistor from T2(2) to T2(1). This will help bleed off voltage from the filter caps in the standby and power-off settings.
- Connect a 3" length of wire from T1(4) to power/standby switch lug 1.
- Connect a 2" length of wire from T1(2) to T2(3).
- Connect a 5" length of wire from T2(5) to power/standby switch lug 2.
- Connect the power cord's white wire to power/standby switch lug 4.
- Connect TR1's white wire to power/standby switch lug 3.

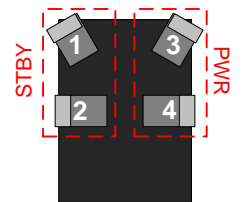

Power/Standby switch

*Double check your work by comparing it with the MOD 102+ Layout Drawing on the last page.*

### MOD102 Schematic

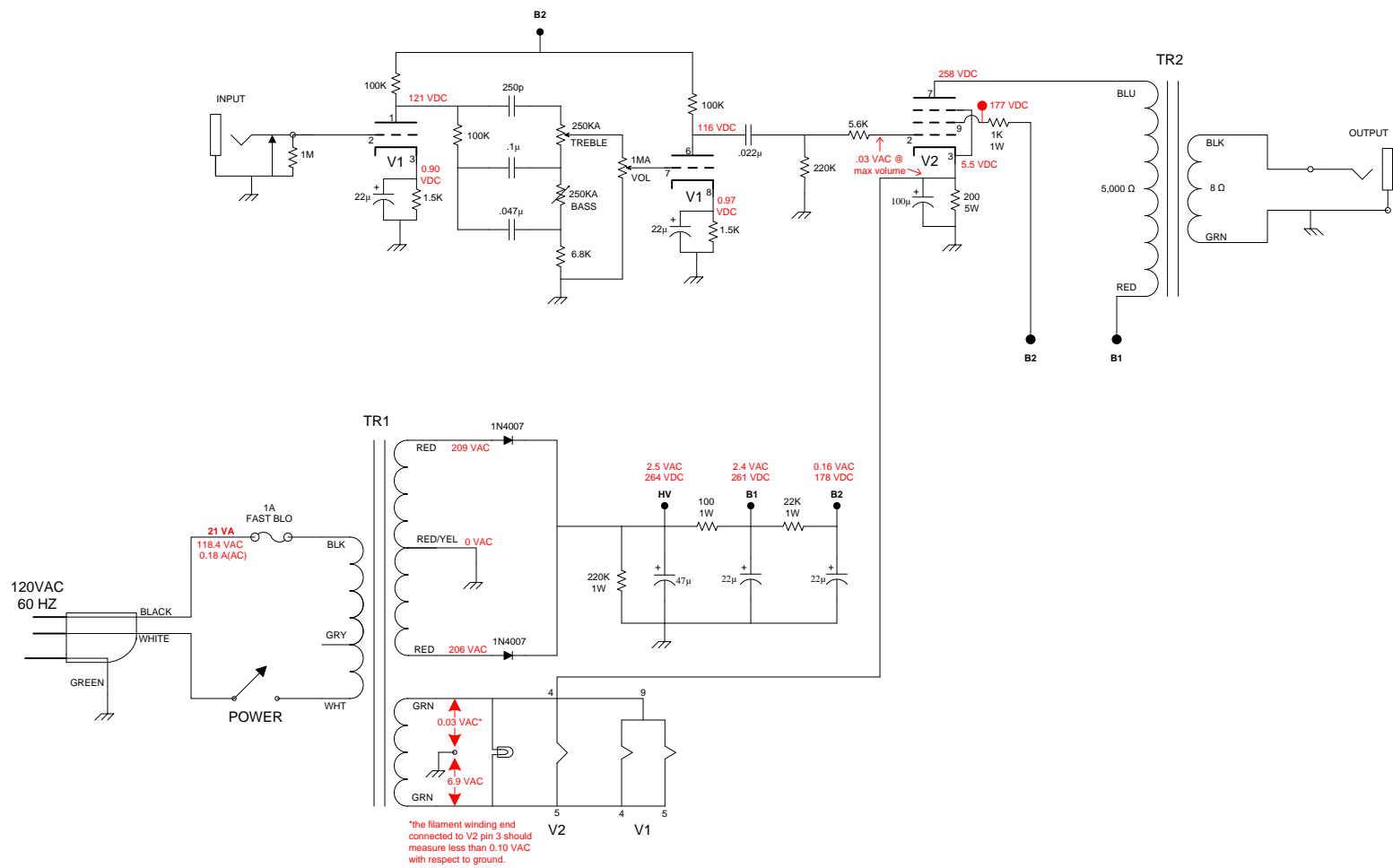

### MOD102 Layout

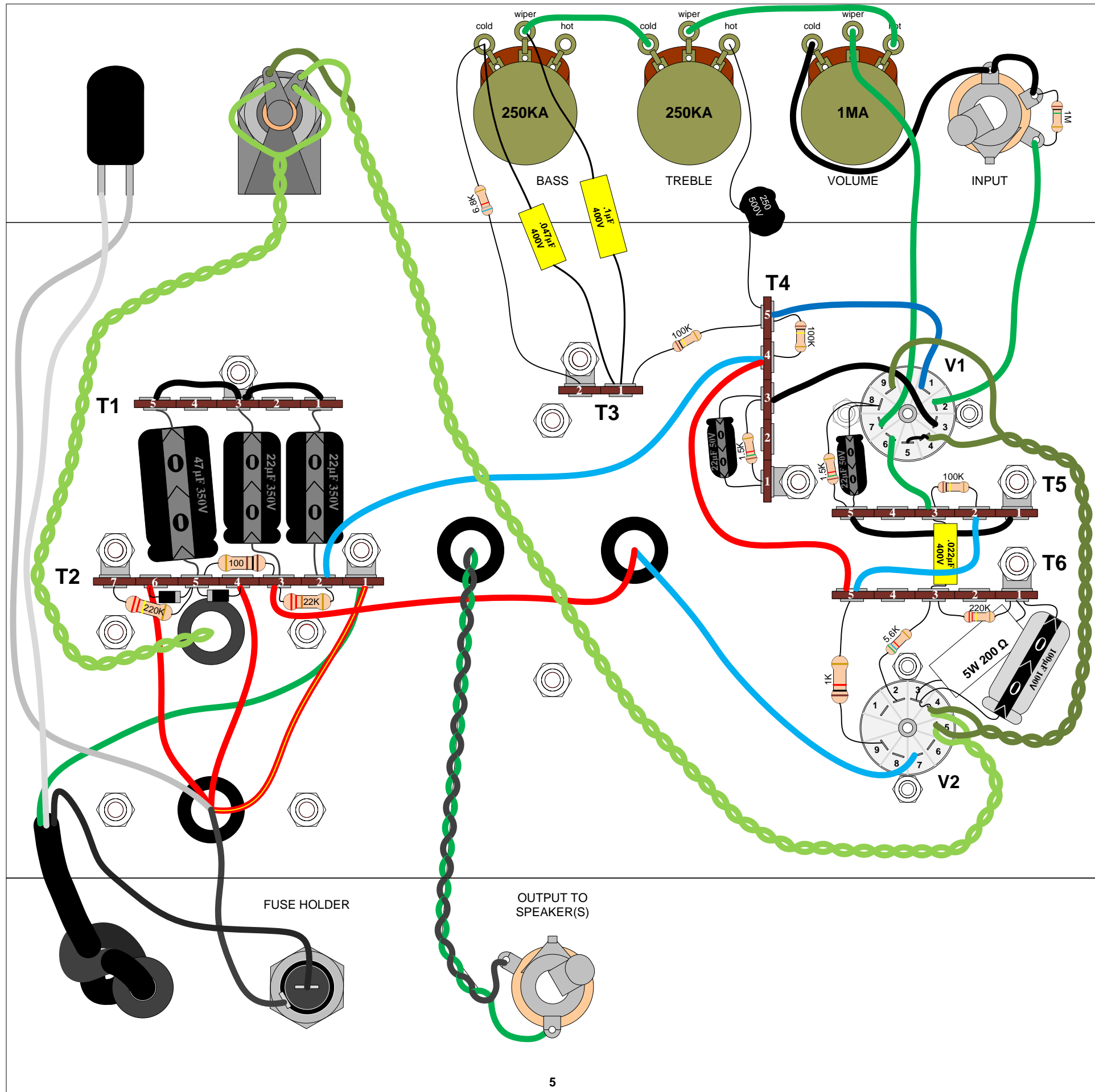

### MOD102+ Schematic

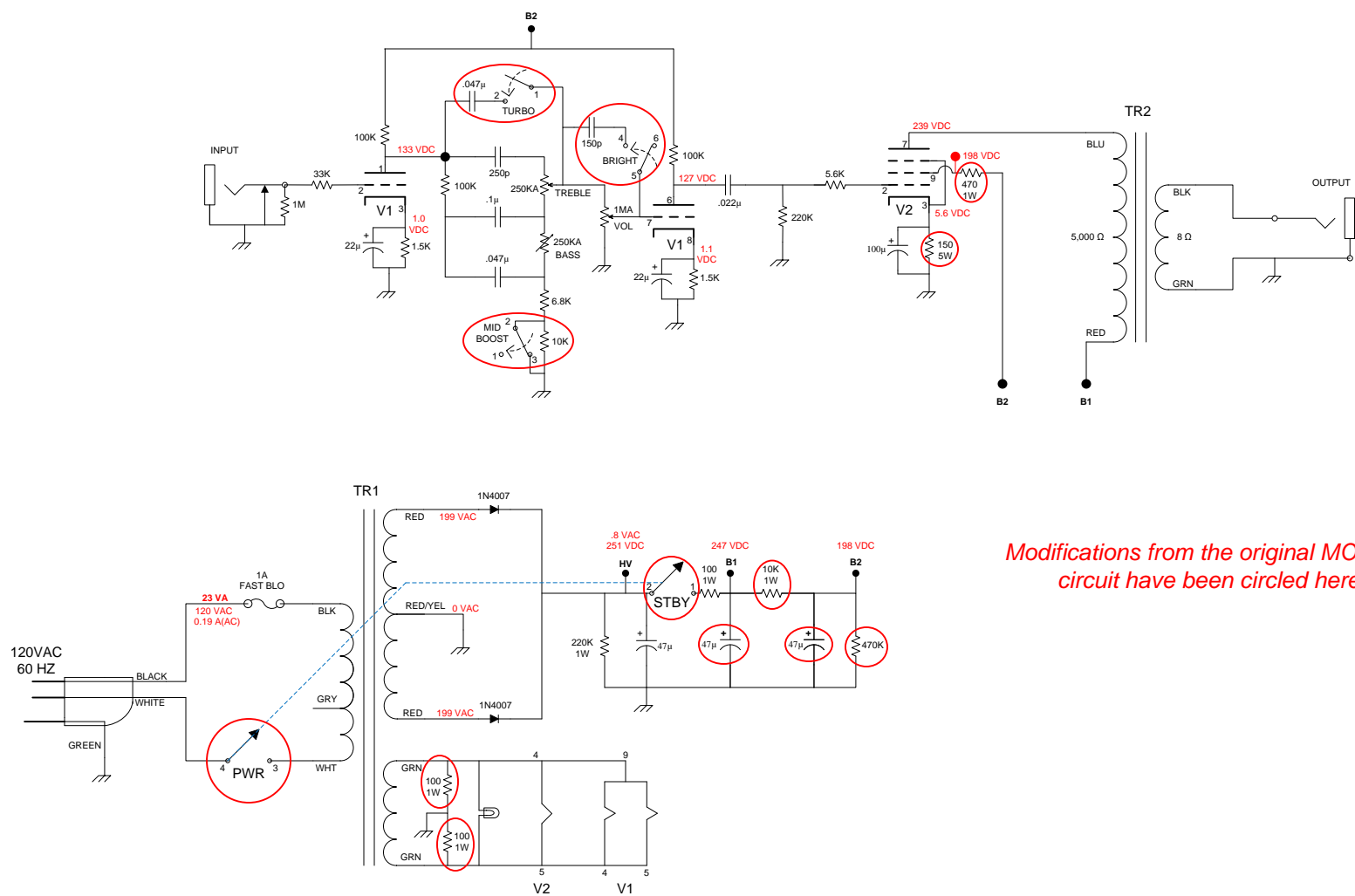

Modifications from the original MOD 102 circuit have been circled here.

### MOD102+ Layout

