

2 TUBE REGENERATIVE RADIO KIT (K-925)

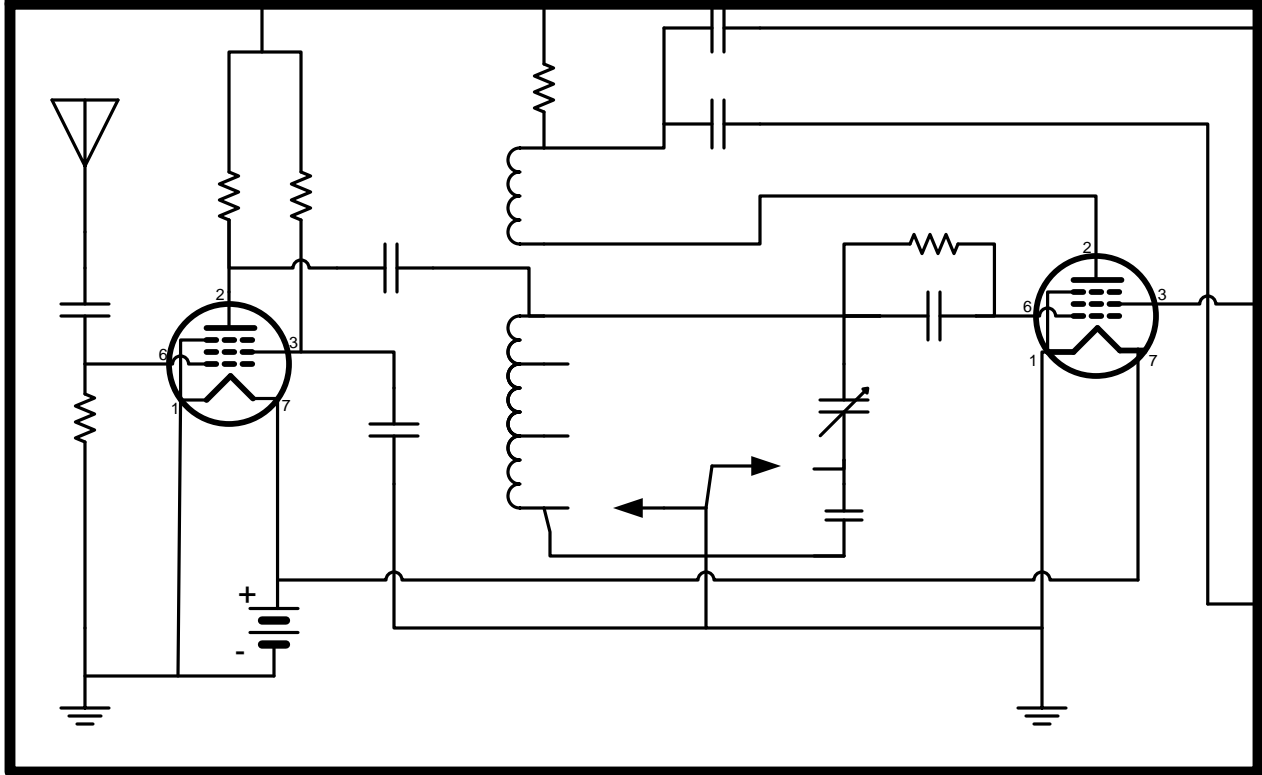

Use these instructions to learn:

- How to build your own regenerative radio set.
- How to wind a coil.



Antique Electronic Supply

Copyright © 2020 by Antique Electronic Supply

Table of Contents

Schematic	3
Tools & Supplies	4
Antenna & Ground Tips	4
Wiring Tips	4
Soldering Tips	4
Parts List	5, 6
Wind the L2 and L1 Coils	7, 8, 9
Assemble the Chassis Floor	9
Assemble the Front Panel	10, 11, 12
Assemble the Front Panel Components	12
Connect Capacitors and Alligator Clips	13
Connect All Resistors	14
Connect Front Panel Wires	14
Connect Front Panel Wires (continued)	15
Connect the Tube Filaments	15
Finish Connecting the Coils	16
Powering Up Your Radio	17
Foil Pattern	18

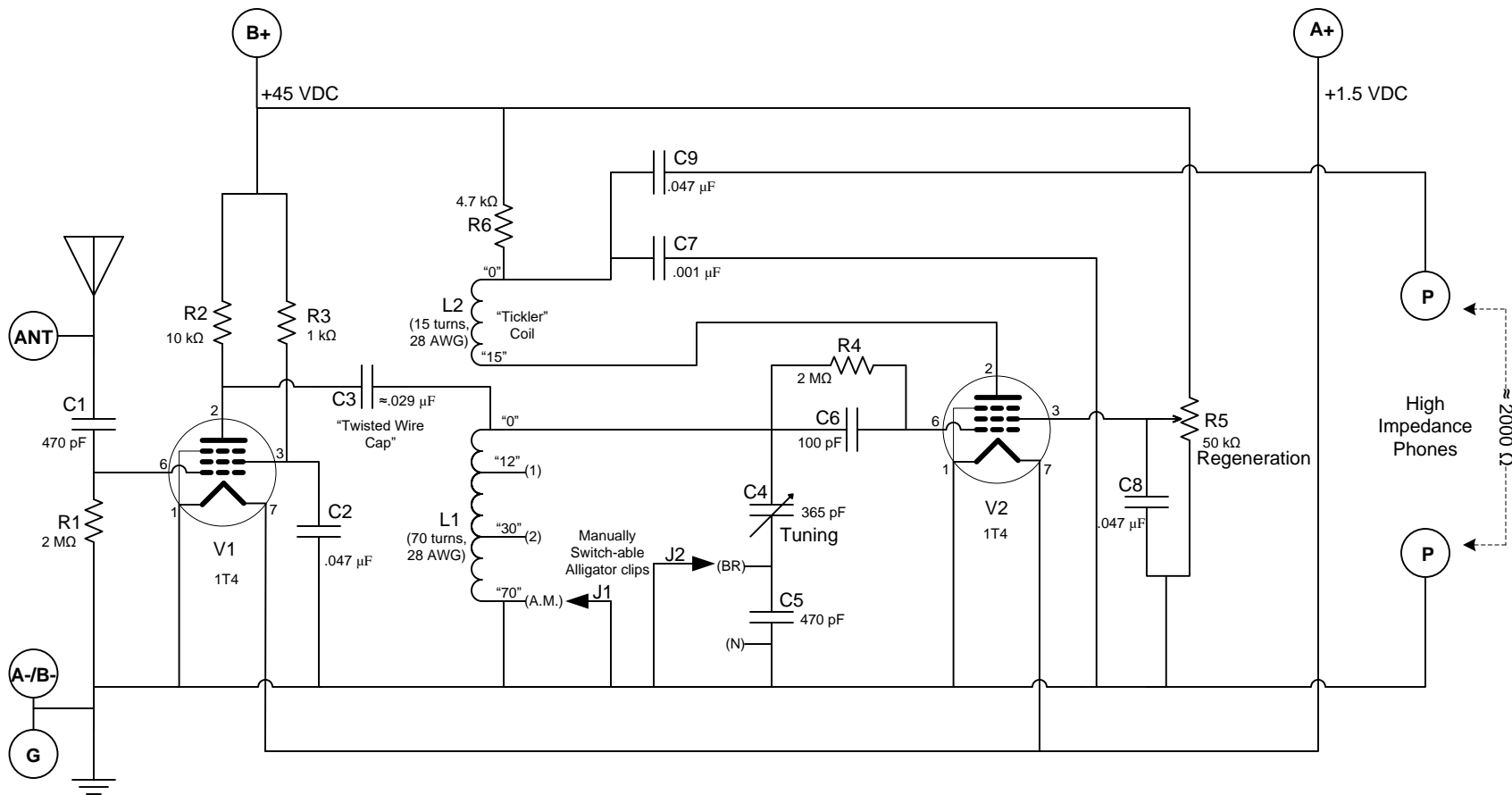

V1 = wide-band RF amplifier
 V2 = regenerative grid leak detector



Copyright © 2020 by Antique Electronic Supply

K-925 Schematic

Introduction:

This radio Kit will cover the AM radio band along with the SW radio band. Power for this receiver is 1.5VDC for the filaments and 45VDC for the plates. Use one “D” cell battery for the 1.5V supply. You can use either one 45V radio battery or five 9V transistor batteries wired in series for the plate supply.

- **A 2k Ω headset or an audio amplifier is required.**
- **Recommended companions:**
 - 1) **AM Wave-Trap (K-934)**
 - 2) **Antenna Tuner (K-935)**

Tools Needed:

- Soldering Iron
- Phillips Head Screwdriver
- Flat Head Screwdriver
- Wire Strippers
- Needle Nose Pliers
- Wire Cutters
- Scissors
- Sharp Knife

Supplies Needed:

- Rosin Core Solder
- White Glue
- Aluminum Foil
- Index Card
- Scotch Tape
- Fine Sandpaper (optional)
- Clear Acrylic Coating
- Two 1T4 Vacuum Tubes

Parts Included:

Please use the Parts list and drawings on the following pages to get organized and make sure you have all necessary parts before putting this kit together.

Antenna & Ground Tips:

It is important to have a substantial antenna and ground in order to receive a strong radio signal. Try some of these antenna and ground suggestions to get more enjoyment out of this kit.

- Use 50 to 100 feet of 16 AWG (American Wire Gauge) stranded aerial wire for the Antenna wire (S-W32-146).
- Hang your antenna in a way that it is kept isolated from ground.
- Use a solid path to “earth” for your Ground wire. You can use water pipes or the grounded screw on a power outlet.

Wiring Tips:

- Unless specified otherwise, use the remainder of 28AWG magnet wire to make the component interconnects after winding the coils.
- Do not cut the wire too long. There should be only a small amount of slack in each wire.
- Use the sharp knife to remove the insulation from both ends of the magnet wire.

SOLDERING TIPS

It is important to make a good solder joint at each connection point. A cold solder joint is a connection that may look connected but is actually disconnected or intermittently connected. (A cold solder joint can keep your radio from working.)

Follow these tips to make a good solder joint.

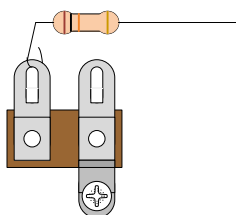

1. Bend the component lead and wrap it around the connection point.

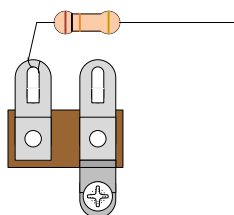

2. Wrap the component lead so that it can hold itself to the connection point.

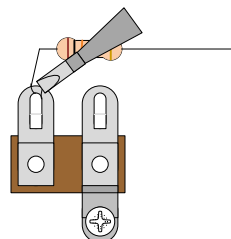

3. Heat up both component lead and connection point with the soldering iron.

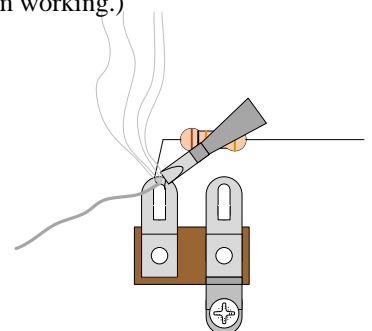

4. Apply solder to both component lead and connection point.

PARTS LIST

Description / (Circuit Name)

470pF Capacitor (C1, C5)

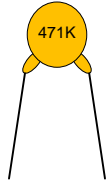

Quantity

2

0.047μF Capacitor (C2, C8, C9)

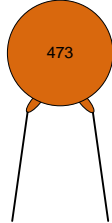

3

0.001μF Capacitor (C7)

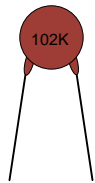

1

100pF Capacitor (C6)

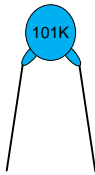

1

2MΩ Resistor (R1, R4)

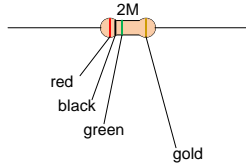

2

1kΩ Resistor (R3)

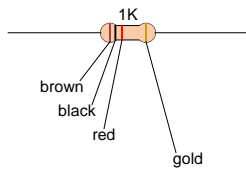

1

10kΩ Resistor (R2)

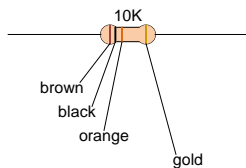

1

4.7kΩ Resistor (R6)

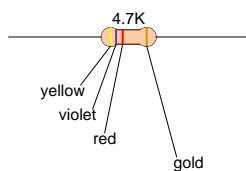

1

Description / (Circuit Name)

365pF Variable Capacitor (C4)

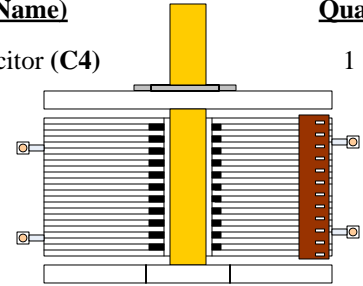

Quantity

1

22 AWG Magnet Wire (C3)

2 ft

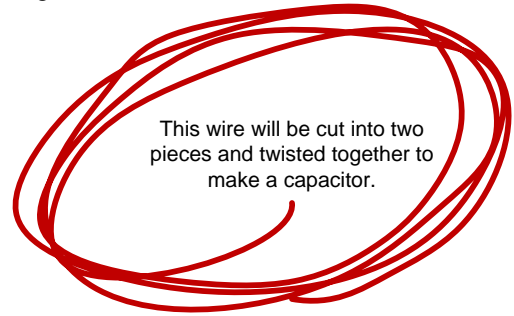

Hookup Wire

2 ft

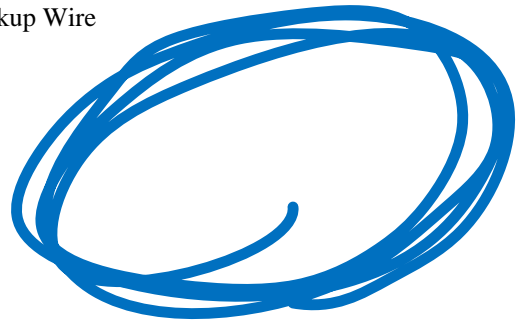

28 AWG Magnet Wire

48 ft

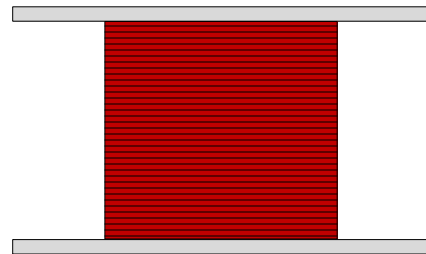





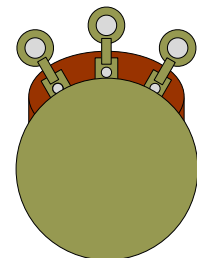



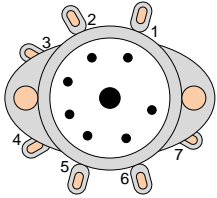
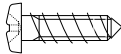
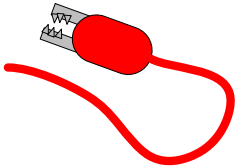
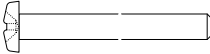

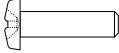
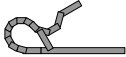
50kΩ Potentiometer (R5)

1

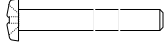
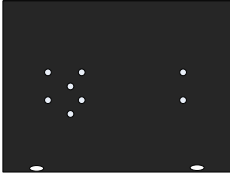

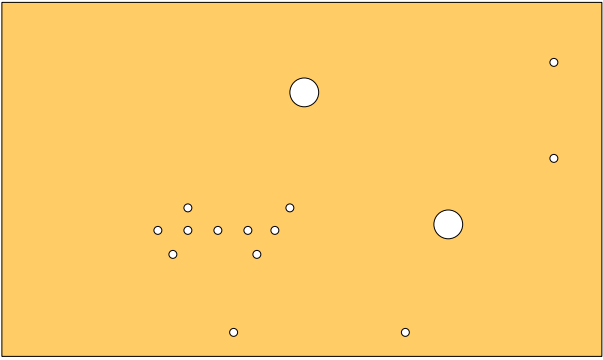
PARTS LIST (CONTINUED)

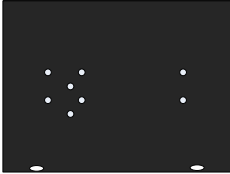
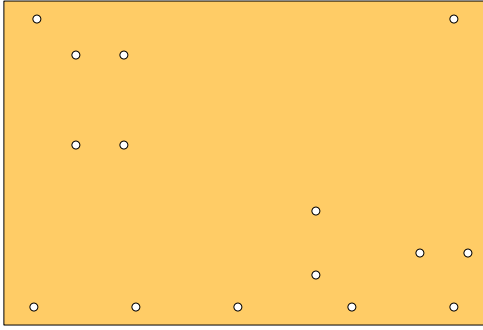
<u>Description / (Circuit Name)</u>	<u>Quantity</u>	<u>Description / (Circuit Name)</u>	<u>Quantity</u>
7-Pin Tube Socket (V1, V2)	2	Wood Screws (#6-32 x 1/2")	9
			
Alligator Clip Lead, 6" (J1, J2)	2	Machine Screws (#6-32 x 1")	2
			
Black Pointer Knob	2	Machine Screws (#6-32 x 1/2")	5
			
Fahnestock Clips	7	Machine Screws (#6-32 x 3/8")	4
			
Solder Lugs	16	Machine Screws (#6-32 x 1/4")	2
			
Spacers (#6 x 3/8")	6	Machine Screws (#4-40 x 3/4")	4
			
Paper Faceplate (Sticker)	1	Hex Nuts 4-40	4
			
Front Panel (4-3/4" x 7-3/4" x 1/8")	1	Hex Nuts 6-32	11
			
Chassis Rails (5/8" x 3/4" x 6-3/8")	2	1T4 Tubes (not supplied)	2
		Coil Form	1
			
		Chassis Panel (4-3/8" x 6-3/8" x 1/8")	1
			

Wind the L2 and L1 Coils

Step 1:

Cut a piece of index card to $\frac{1}{2}$ " x 2". Set aside.

$\frac{1}{2}$ " x 2"
Index card



Not supplied

Step 2:

Hold the coil form in your hand with the two large mounting holes facing leftward and the eight small pinholes facing up toward the ceiling.

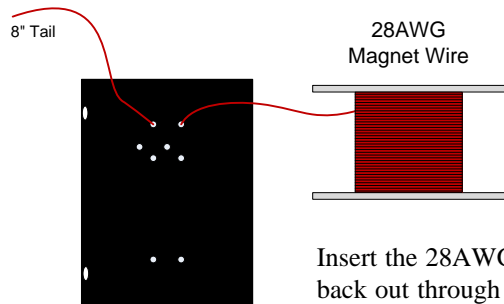

Insert the 28AWG wire through the top right pinhole and then pull the wire back out through the top left pinhole. Pull it tight. (Pull out an 8 inch tail which will be soldered to a solder lug later in the instructions).

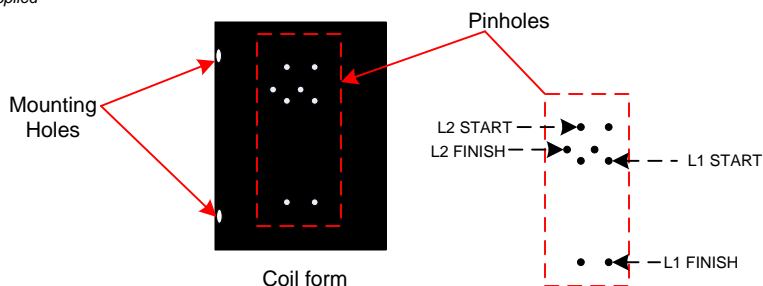

Before you begin winding the coil keep the following in mind:

- After you have wound both coils, the Clear Acrylic Coating will be brushed (or sprayed) over the windings to hold them in place permanently.
- Take your time and make each turn of the coil tight and side by side with the previous turn without crossing over or under the previous turn.
- Avoid making any kinks in the wire as you wind each turn.
- Be careful not to cover up the mounting holes.

Step 3:

Place the $\frac{1}{2}$ " x 2" piece of cardstock on the coil form just to the right of the pinholes. Make sure that the length of the cardstock is to the right of each set of pinholes. (You might find it easier to temporarily hold the cardstock in place with a couple pieces of scotch tape).

Begin winding the wire over the cardstock and around the coil form in the clock wise direction as shown in the drawings.

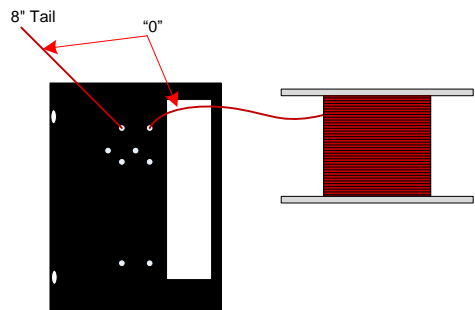

Step 4:

Continue winding 15 turns of wire around the coil form.

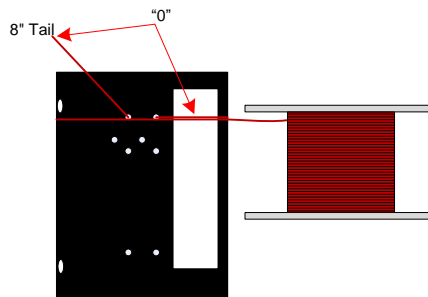

After the 15th turn, continue around the coil form and insert the wire through the bottom left L2 pinhole and then pull it out through the bottom right L2 pinhole. Pull it tight leaving another 8" tail (to be soldered to a tube pin later).

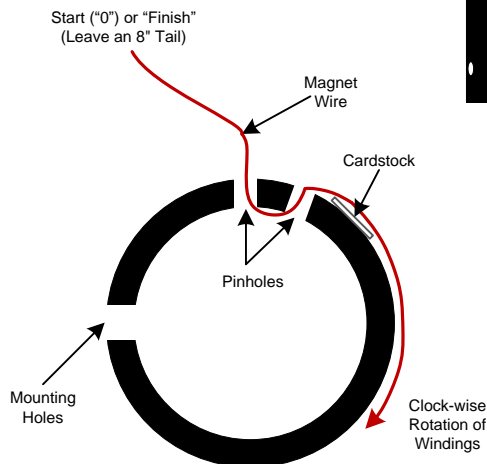
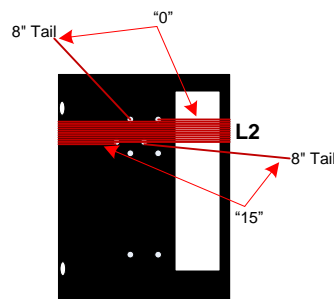

Step 5:

Insert the 28AWG magnet wire through the L2 top right pinhole and pull it back out through the L2 top left pinhole leaving an 8" tail. Pull the tail tight. (It will be soldered to the variable capacitor later).

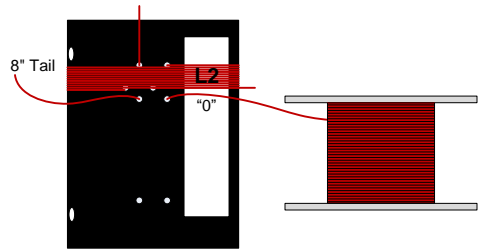

Begin winding one turn of wire over the cardstock and around the coil form in the clock wise direction as shown in the drawing.

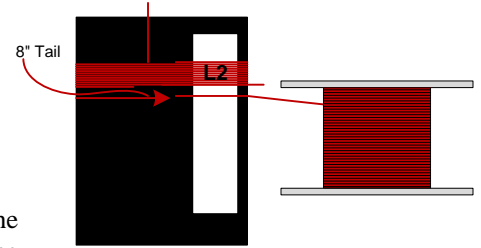

Step 6:

After passing one turn over the cardstock, lift up the remainder of the cardstock in order to wind the next 11 turns underneath the cardstock.

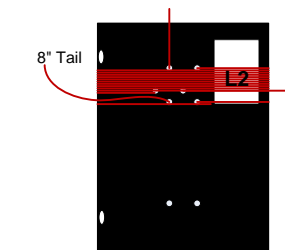

Step 9:

After the 17 turns have been wound underneath the cardstock, bring the cardstock back down and wind the 18th turn over the top of the cardstock.

Lift the card stock up for the next 39 turns.

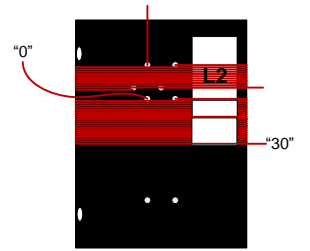
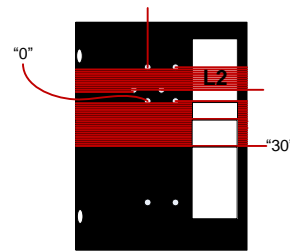

Step 7:

After the 11 turns have been wound underneath the cardstock, bring the cardstock back down and wind the 12th turn over the top of the cardstock.

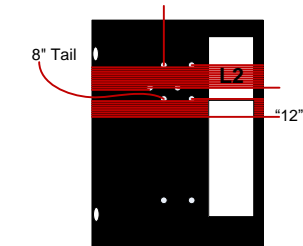

Step 10:

After the 39 turns have been wound underneath the cardstock, bring the cardstock back down and wind the 40th turn over the top of the cardstock.

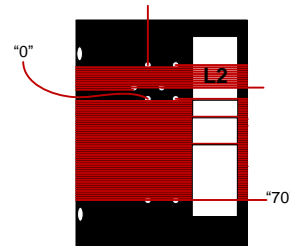

Step 8:

Lift up the remainder of the cardstock in order to wind the next 17 turns underneath the cardstock.

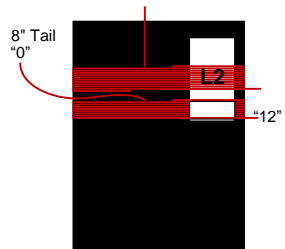

After the 40th turn (70 turns total), continue around the coil form and insert the wire through the bottom left L1 pinhole and then pull it out through the bottom right L1 pinhole. Pull it tight leaving another 8" tail (to be soldered to a solder lug later).

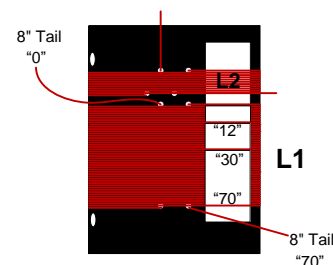

Step 11:

Use the sharp knife to scrap the red insulation from the wire over the cardstock at "12" and "30".

Tin the bare magnet wire with solder so that you can connect your wire taps at these points later.

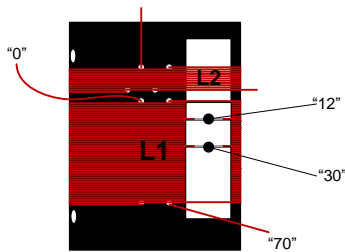

Step 12:

Cover "12" and "30" with scotch tap to keep them untouched by the Clear Acrylic Coating.

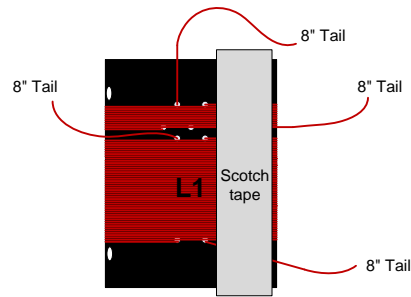

Make sure you are in a ventilated area and thoroughly brush or spray on a clear acrylic coating all around the windings. Allow this coating to dry. (It should take a few hours).

Assemble the Chassis Floor

Step 1:

Use seven wood screws provided to attach the chassis rails to the bottom of the chassis panel. Attach the 5/8" edge of the chassis rail to the chassis floor.

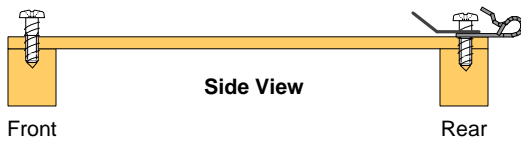

On each of the rear rail screws, place the Fahnestock clips with the solder lugs on top as shown.

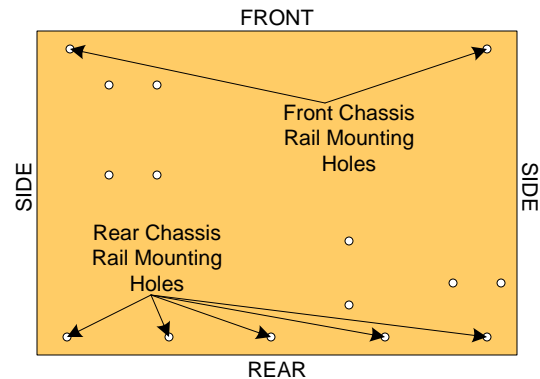

Step 2:

Mount two solder lugs for the C9 capacitor using 3/8" machine screws and nuts provided.

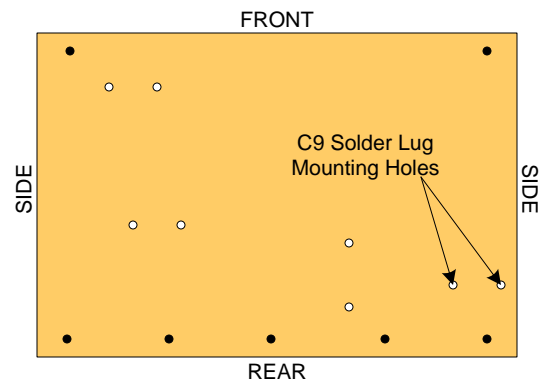
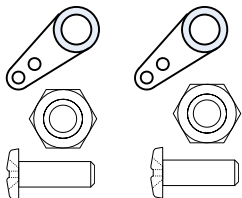

Step 3:

Find the two 7-pin tube sockets, cut and remove the isolated center pin, then bend the seven solder lugs upward to facilitate soldering to them. Mount these tube sockets to their respective locations (V1 & V2) using 3/4" machine screws, nylon spacers and hex nuts.

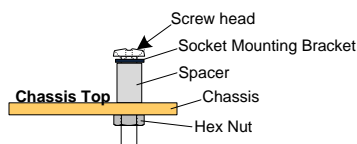

Mount the sockets with pins 1 and 7 in the same orientation as in this drawing.

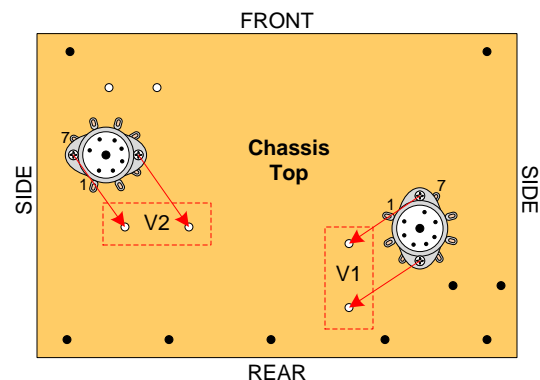

Step 4:

Mount the variable capacitor (C4) to the chassis using the two 1/4" machine screws and one solder lug.

Bend C4's four solder lugs upward to facilitate soldering to them.

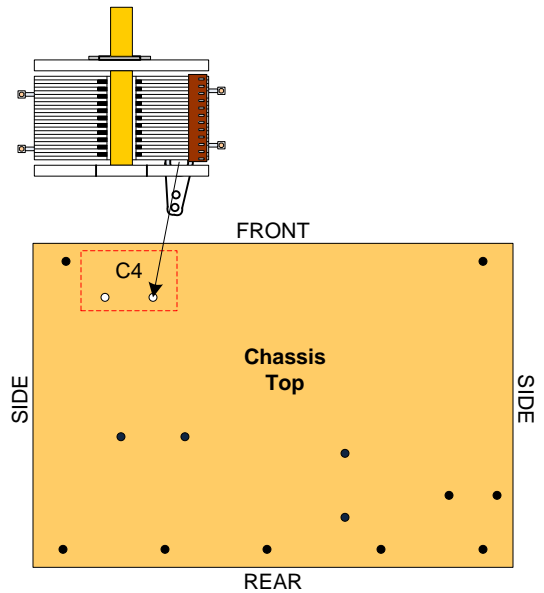
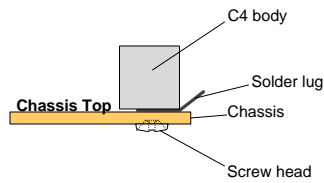

Assemble the Front Panel

Step 1:

- Cut out a sheet of tin foil that is larger than the included foil pattern (p. 18).
- Cut the foil pattern out along the outside edge.

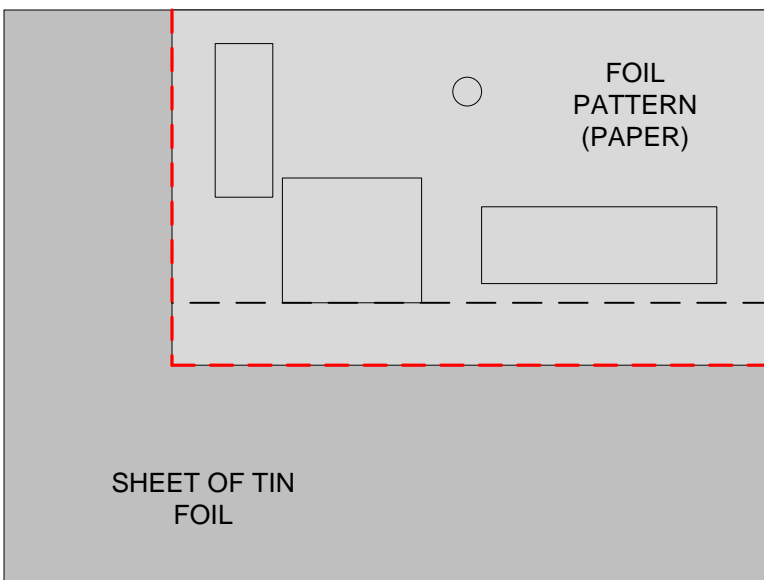
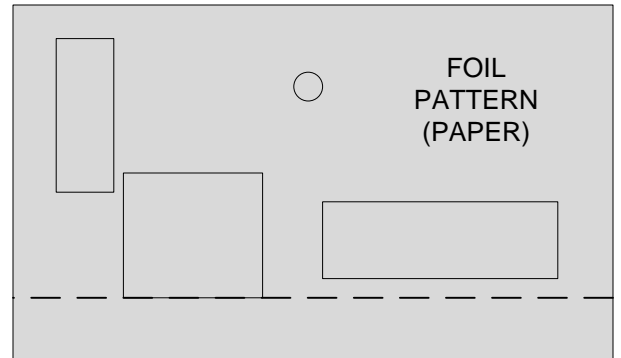
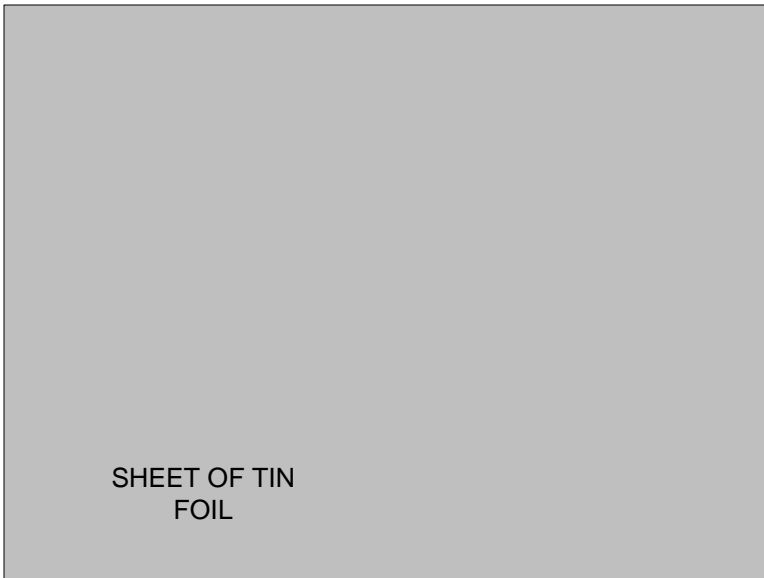

Step 2:

Place the foil pattern over the sheet of tin foil and trace along the foil pattern edge.

Cut the sheet of tin foil to the size of the foil pattern.



Step 2:

Cut the paper foil pattern along the dotted line. Place the foil pattern over sheet of tin foil lining its top edge to that of the foil. Trace along the edge where the dotted line was.

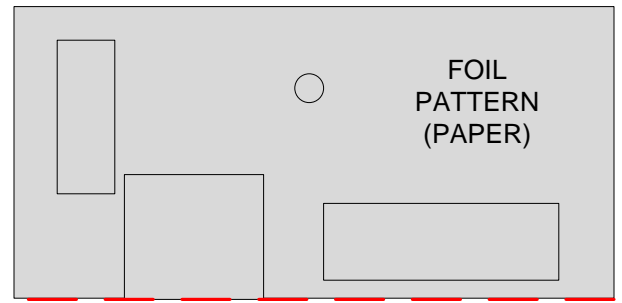
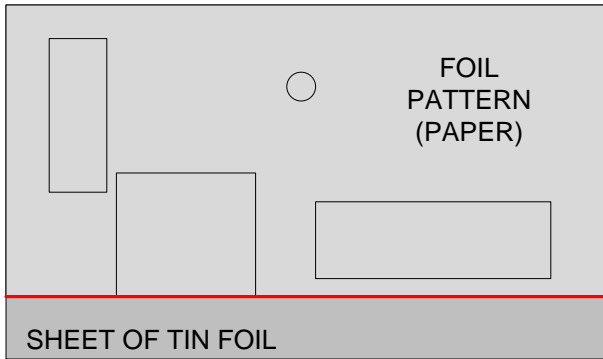

Step 3:

Remove the paper foil pattern. Cover the tin foil with glue above the traced line.

Place the paper foil pattern back on to the tin foil where the glue is and allow the glue to dry.

Step 4:

After the glue has dried, cut out the pieces indicated on the paper foil pattern. Use either a pair of scissors or precision blade to remove both tin foil and paper where indicated on the foil pattern.

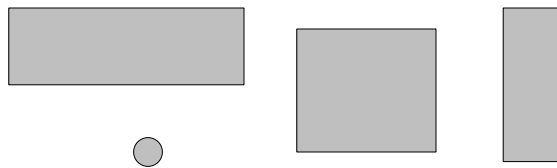
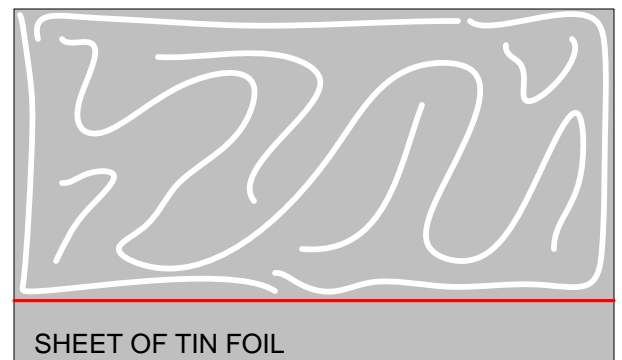
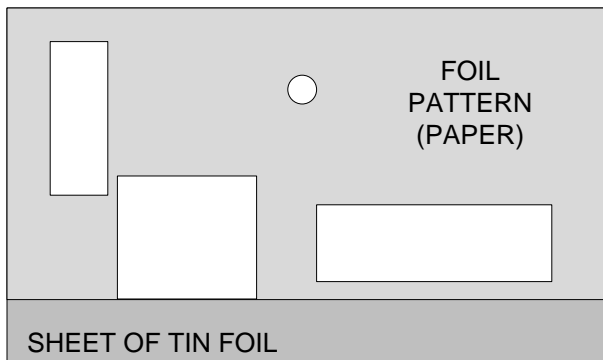

Step 5:

Apply glue to the tin-foil-only side of the paper and tin foil pattern.

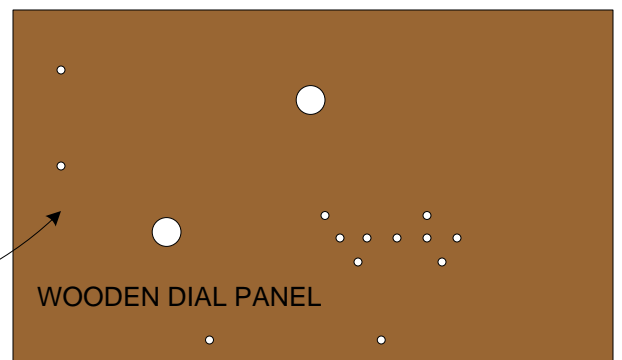
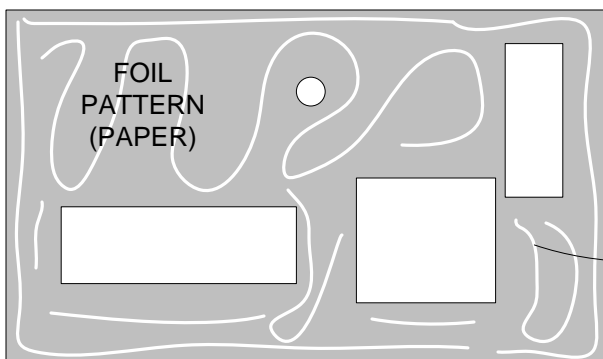

Lay the glue side of the paper and tin foil pattern on to the wooden front panel and allow the glue to dry. Make sure to line up the two large holes in the front panel as shown to the right.

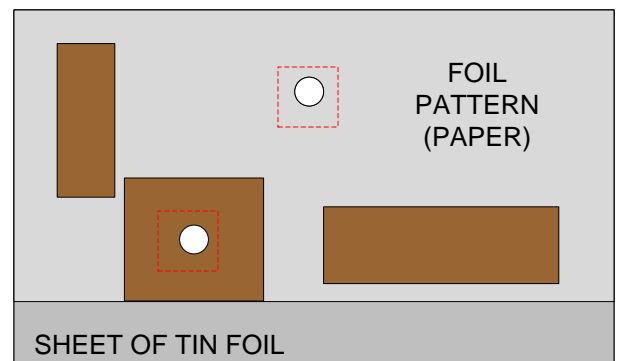

Step 6:

Cut along the outer edge of the face plate sticker. Stick it to the front panel on the opposite side from the foil pattern. Be careful to line up the two holes for the “Regeneration” and “Tuning” knobs.

Once the sticker is in place you can punch out the paper over the holes in the wooden front panel.

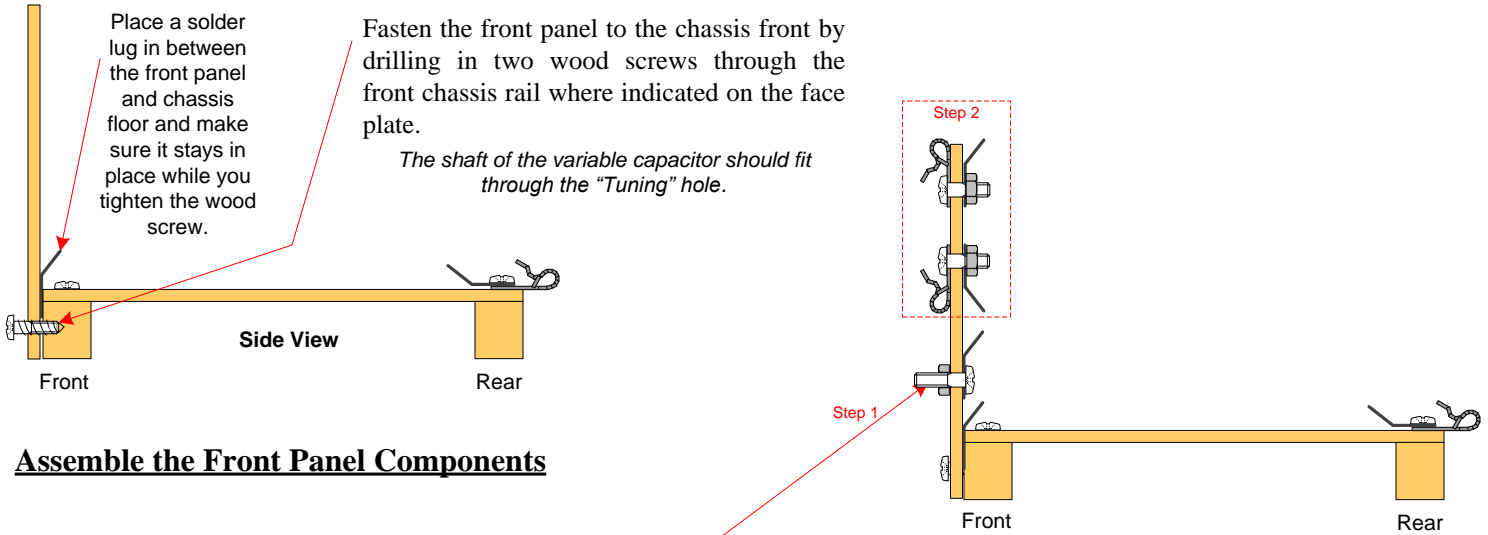

Assemble the Front Panel Components

Step 1:

Mount the five band select terminals (“A.M., 1, 2, N, BR”) with the ½” machine screws, solder lugs and hex nuts. Point the lugs upwards to facilitate soldering to them.

Step 2:

Mount the two “Phones” Fahnestock clips to the front panel with two 3/8” machine screws, solder lugs and hex nuts.

Step 3:

Mount the R5 “Regeneration” potentiometer to the front panel with its solder lugs pointing towards the chassis floor. Use the mounting hardware provided on the potentiometer. Place the flat washers on both sides of the wood front panel. (It may be necessary to clip or bend back the small locating tab on the pot).

Step 4:

Mount the black pointer knobs to the potentiometer and variable capacitor by tightening the set screw.

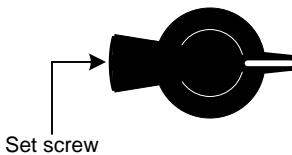

Step 5:

After the coil has dried, carefully peel off the scotch tape covering the “12” and “30” taps.

Fasten the coil to the front panel using two spacers, 1” machine screws and hex nuts (as in the drawing). Be careful not to pinch any of the windings when tightening the nylon spacers.

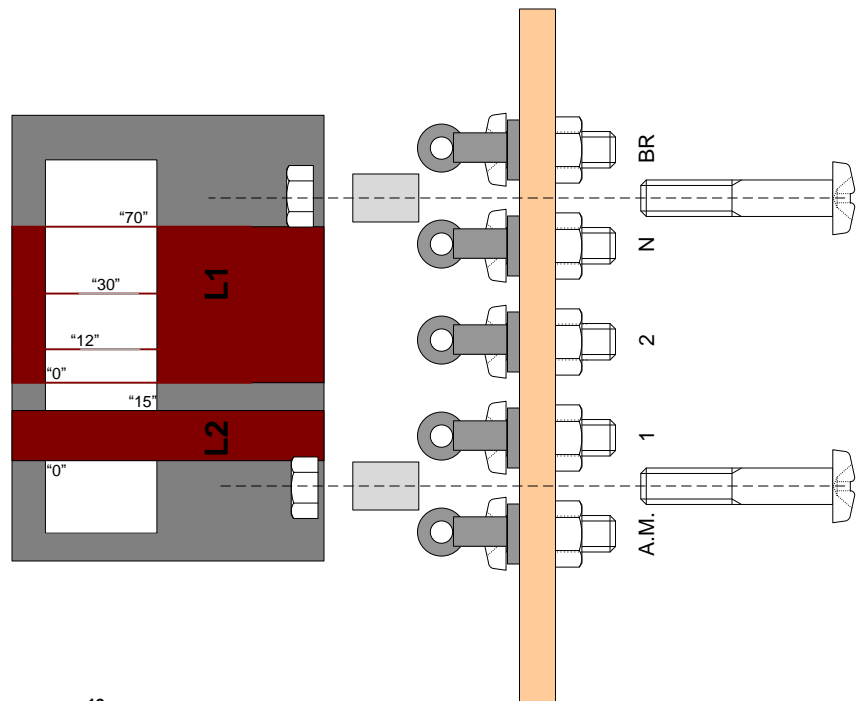

Connect Capacitors and Alligator Clips (J1 & J2)

Step 1:

Connect all of the capacitors (C1 – C9) as in the drawing below.

C3 is made by twisting together two pieces of 22AWG magnet wire for about two inches. Do not allow the ends to “short” electrically to each other. (They should be physically held together but not electrically connected to each other).

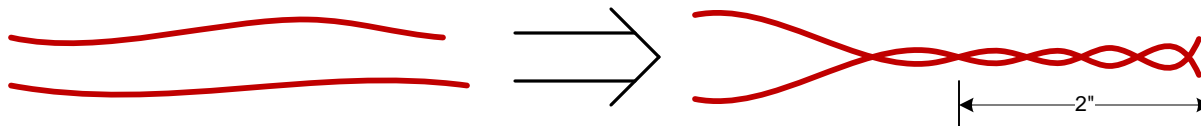

Step 2:

Connect J1 and J2 as in the drawing. They should be inserted through their respective holes in the front panel before soldering their connections.

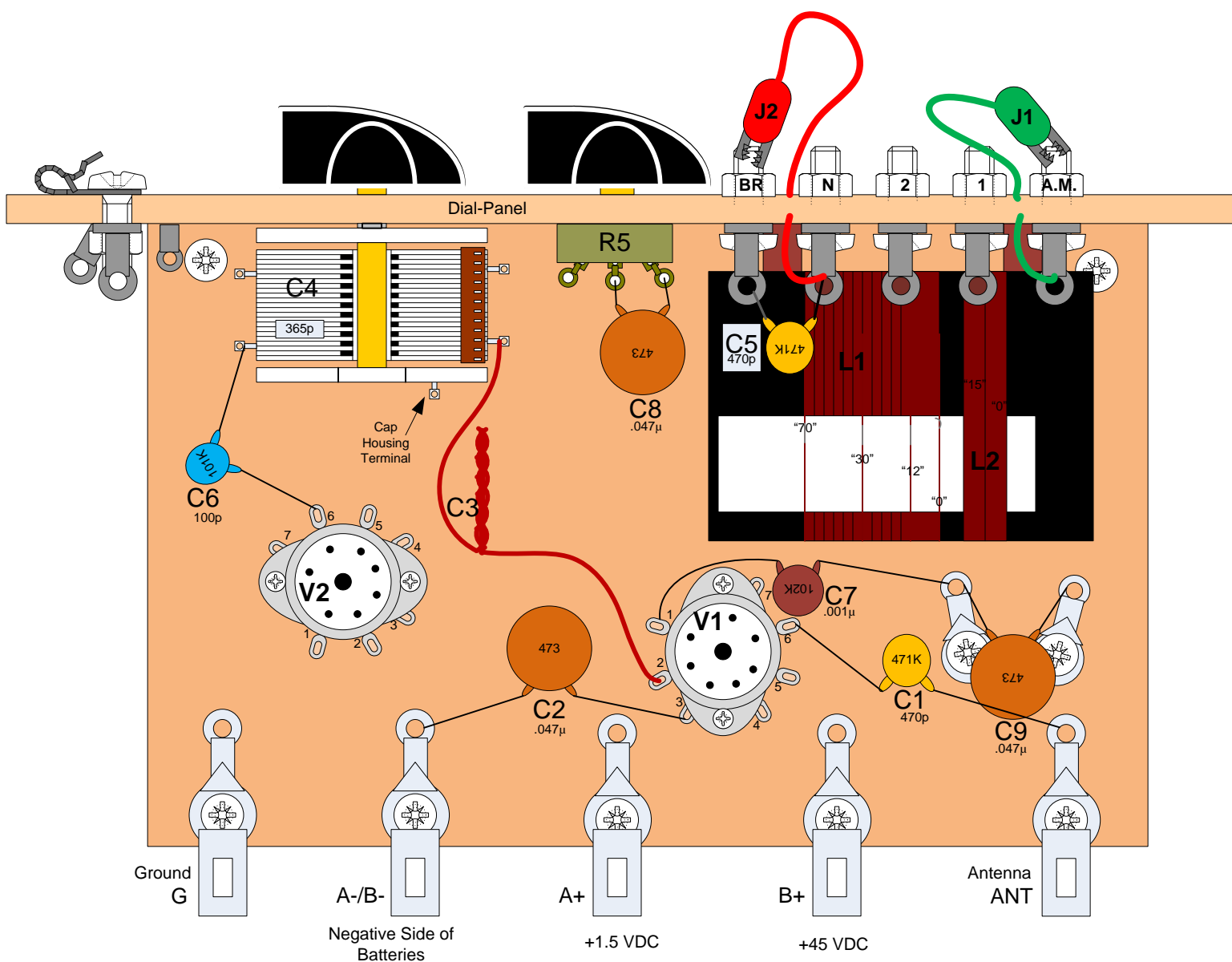

Connect All Resistors (R1 – R6)

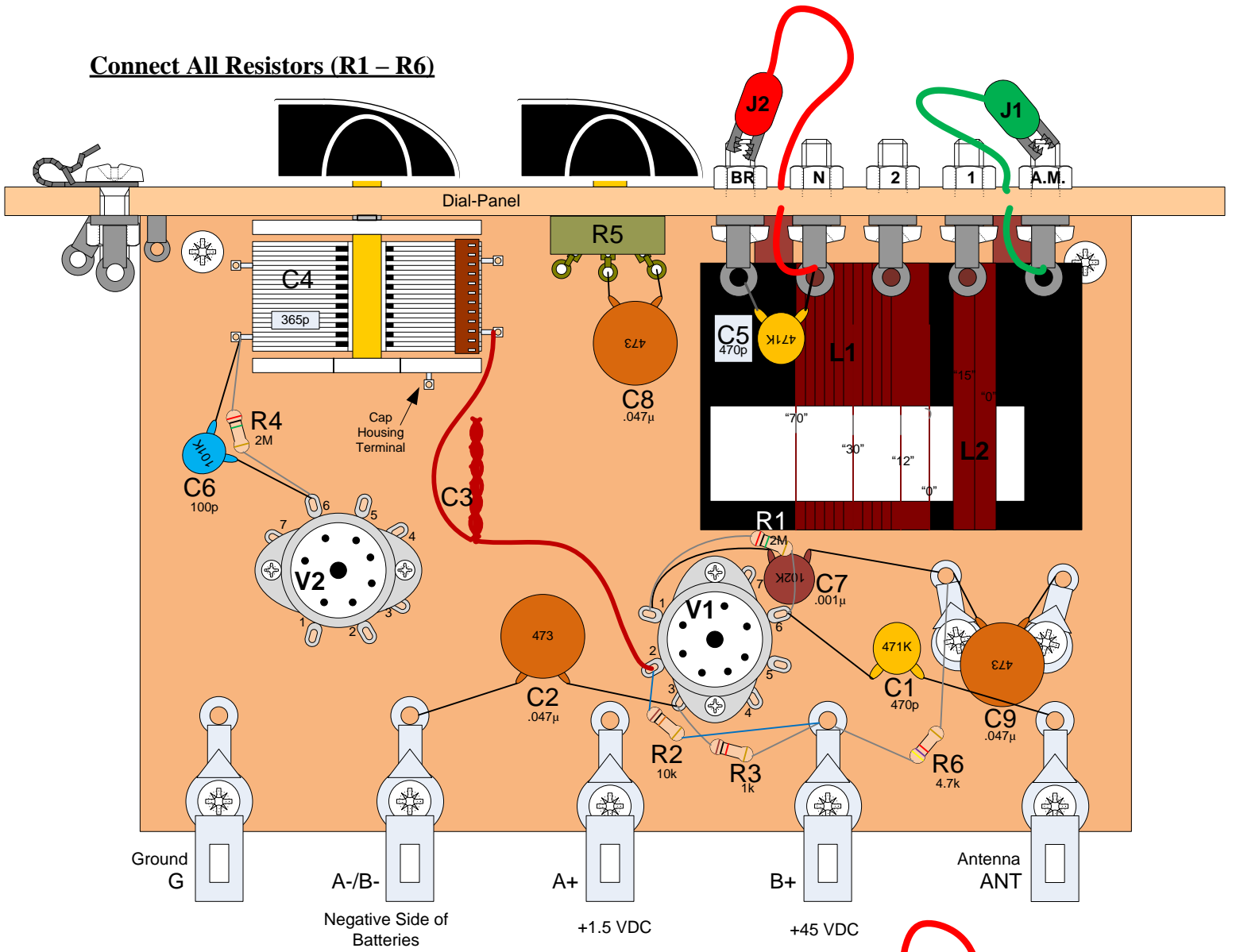

Connect Front Panel Wires

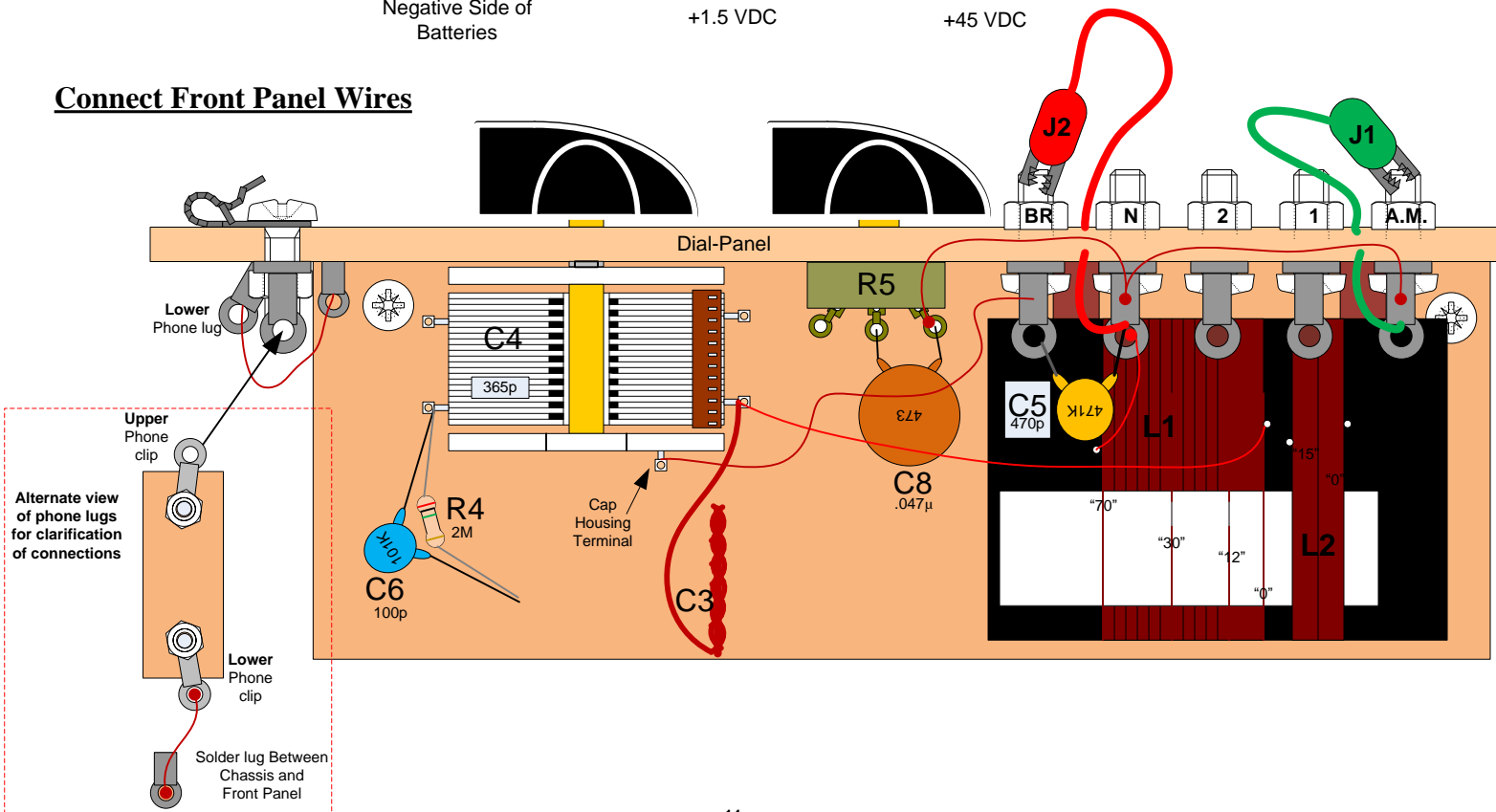

Connect Front Panel Wires (continued)

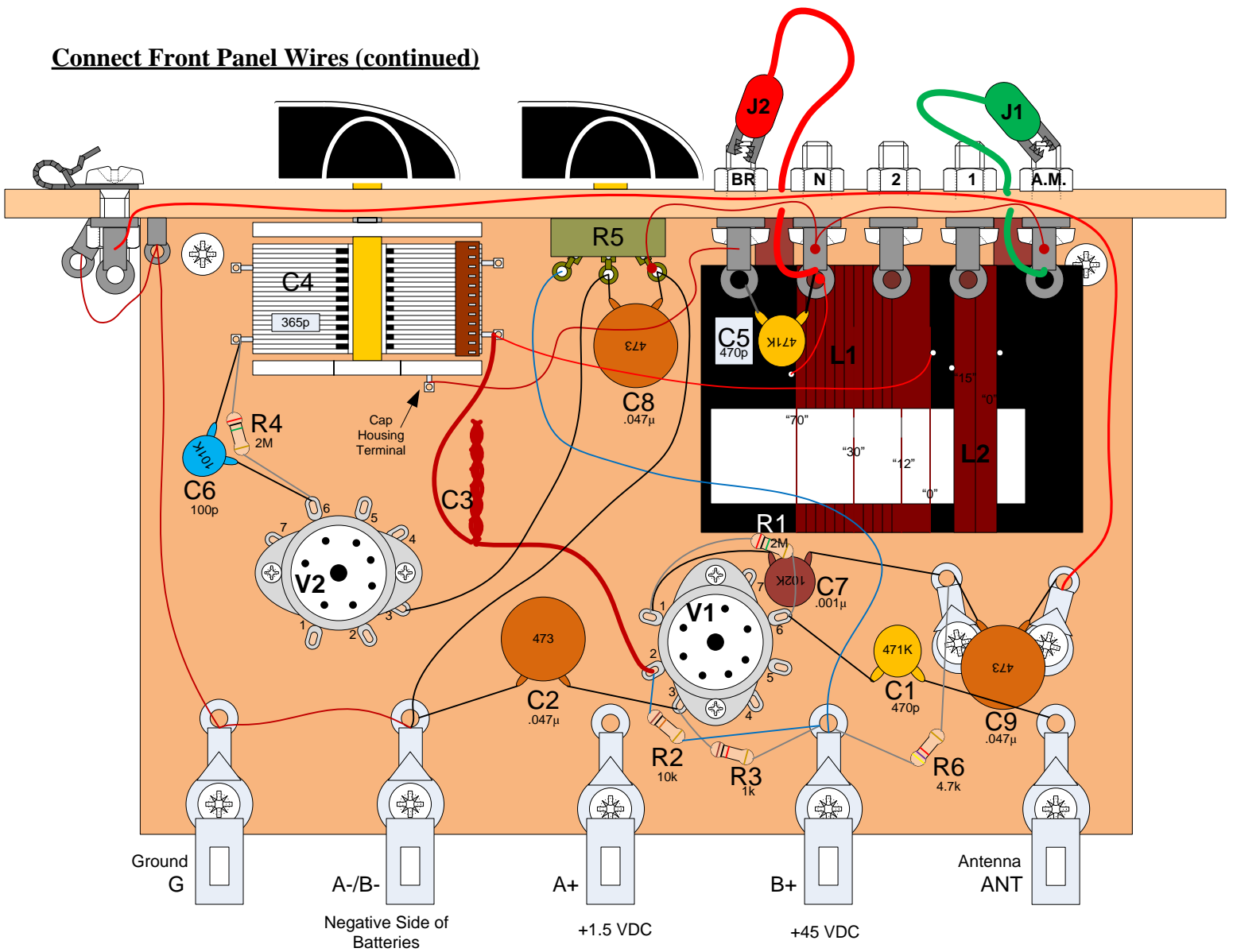

Connect the Tube Filaments

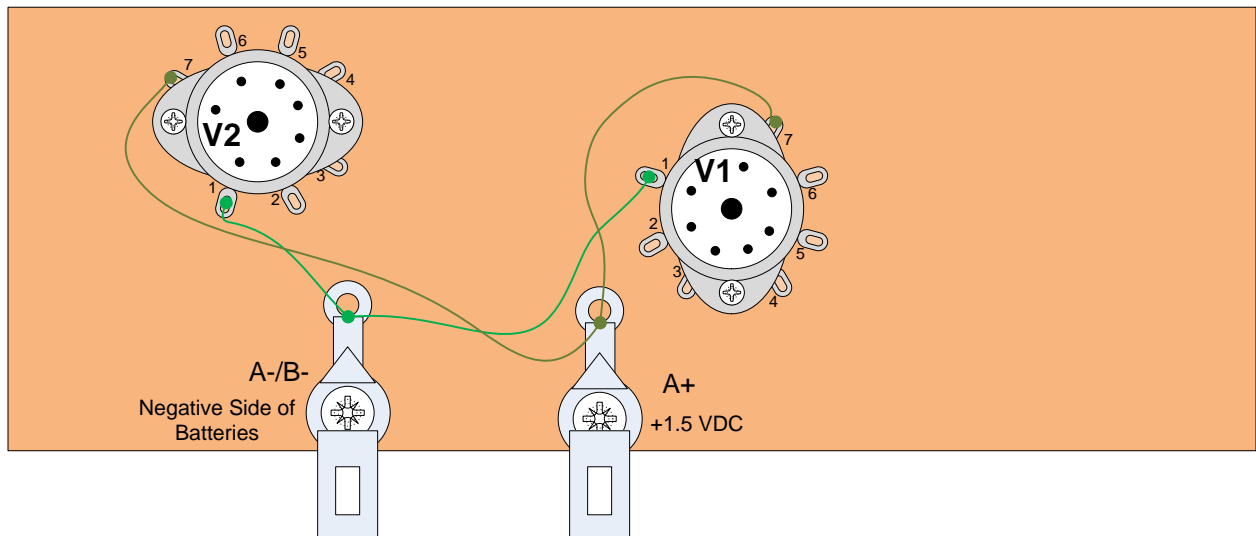

Finish Connecting the Coils

How to connect to the taps

Use hookup wire for the "12" and "30" L1 taps.

- Strip the ends of the hookup wire.
- Tin the end of the hookup wire to be connected to the taps.
- Place the hookup wire right beside the tinned portion of the tap so that they are touching.
- Heat them up and let it cool down so that the hookup wire is now connected to the tap.

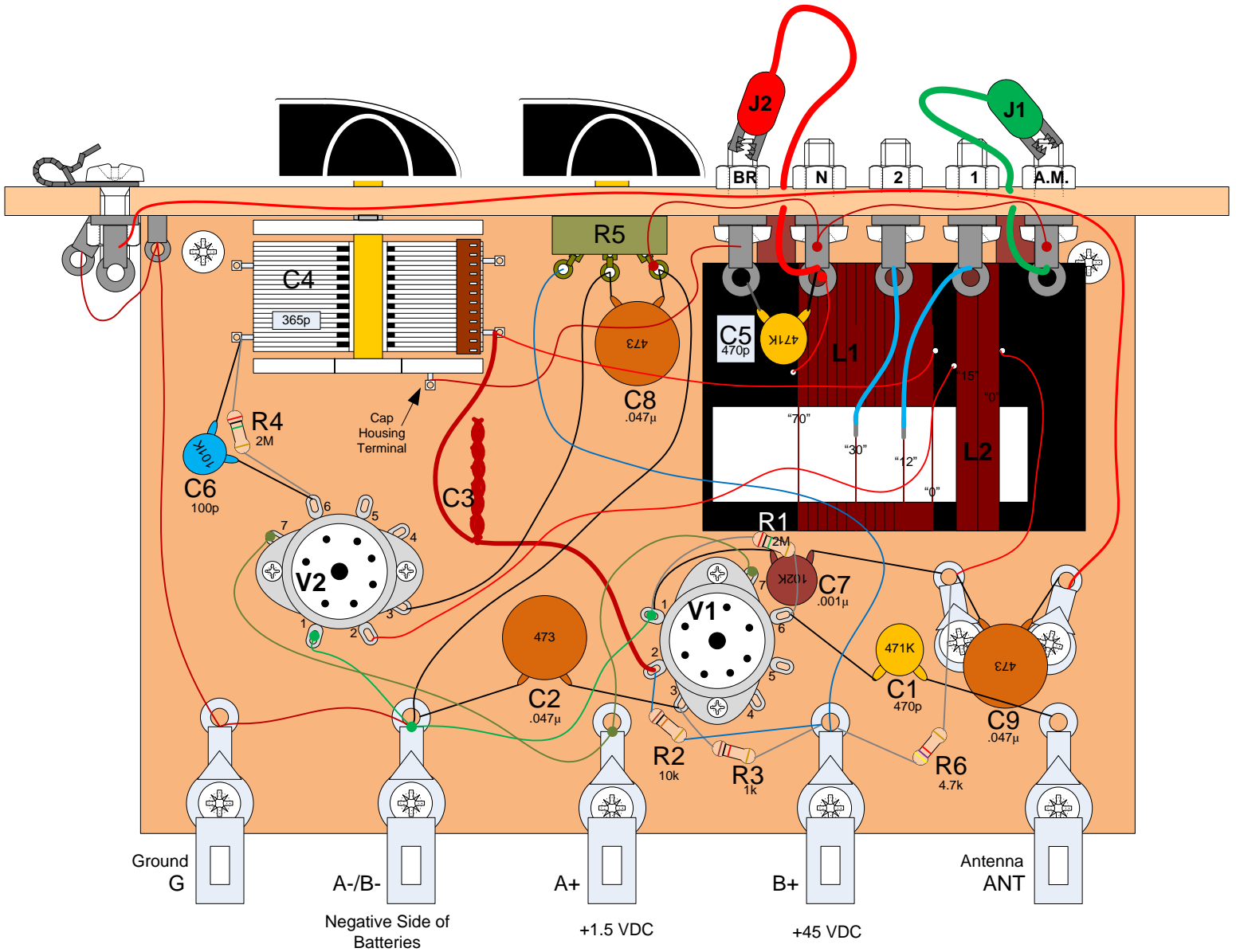

Double Check Your Connections

That completes the assembly. Always double check your work before applying power.

Powering Up Your Radio

Step 1

Install the tubes into the sockets.

Step 2

Connect your antenna, ground and headphones to the correct terminals.

Step 3

Connect all the battery terminals.

Step 4

- Clip J1 to “A.M” and J2 to “BR”.
- Put on your headphones.
- Turn the “Regeneration” control all the way clockwise.
- Slowly rotate the “Tuning” knob until you receive a station or a squeal.
- Fine tune the station by trying different “Regeneration” positions and slightly turning the “Tuning” knob to find where the station is the loudest and/or clearest.

The same method is used for the shortwave bands. Use the “N” (narrow) terminal for adjusting the two shortwave bands. This will help to “spread” the stations. (If you want to listen to single-sideband, adjust the Regeneration knob to a squeal setting).

Congratulations on completing your 2-Tube Regenerative Radio!

18

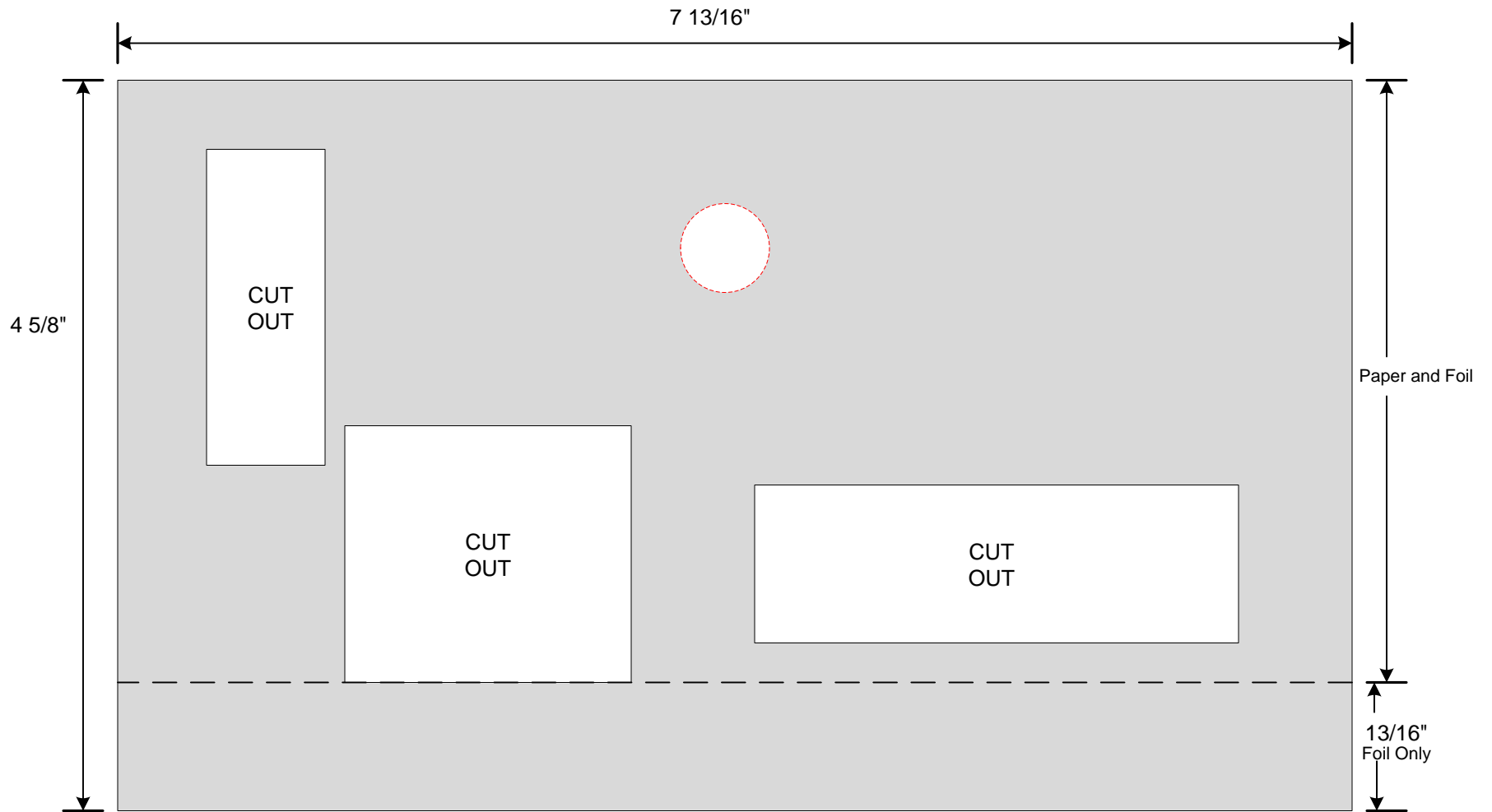

Foil Pattern

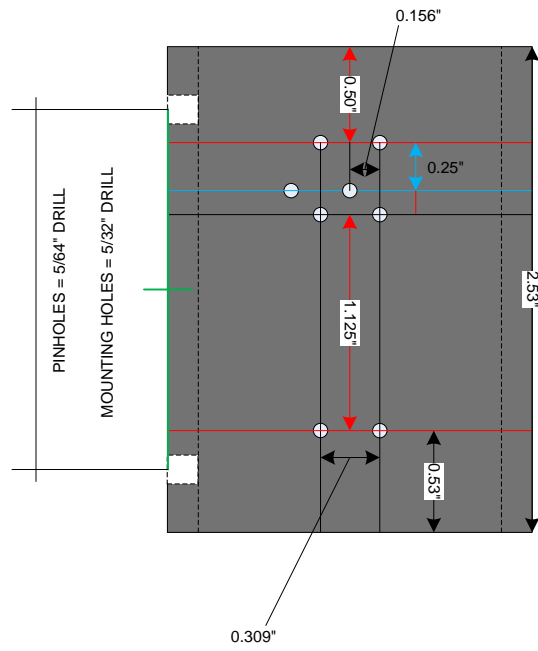

Coil Form Hole Details