

— PRODUCT INFORMATION —

# Sharp-Cutoff Pentode

**12GN7-A**

FOR TV VIDEO AMPLIFIER APPLICATIONS

The 12GN7-A is a miniature, sharp-cutoff pentode designed primarily for video amplifier service in television receivers.

## GENERAL

### ELECTRICAL

Cathode - Coated Unipotential

Heater Characteristics and Ratings

	Parallel Sections, Series Circuit*	Parallel Sections, Parallel Circuit†	Series Sections, Parallel Circuit‡	
Heater Voltage, AC or DC . . . . .	6.3 $\overline{\text{M}}$	6.3±0.6#	12.6±1.3#	Volts
Heater Current . . . . .	0.6±0.04#	0.6Δ	0.3¢	Amperes
Heater Warm-up Time, average** . . . . .	11	---	---	Seconds
Direct Interelectrode Capacitances##				
Grid-Number 1 to Plate: (g1 to p) . . . . .			0.12	pf
Input: g1 to (h + k + g2 + g3 + i.s.). . . . .			17.5	pf
Output: p to (h + k + g2 + g3 + i.s.). . . . .			4.0	pf

### MECHANICAL

Operating Position - Any

Envelope - T-6 1/2, Glass

Base - E9-1, Small Button 9-Pin

Outline Drawing - EIA 6-3

Maximum Diameter. . . . .	0.875	Inches
Maximum Over-all Length . . . . .	2.625	Inches
Maximum Seated Height . . . . .	2.375	Inches

## MAXIMUM RATINGS

### DESIGN-MAXIMUM VALUES

Plate Voltage. . . . .	400	Volts
Screen Supply Voltage . . . . .	330	Volts
Screen Voltage - See Screen Rating Chart		
Positive DC Grid-Number 1 Voltage . . . . .	0 $\overline{\text{S}}$	Volts
Plate Dissipation . . . . .	11.5	Watts
Screen Dissipation . . . . .	1.5	Watts
Grid-Number 1 Circuit Resistance . . . . .	0.25	Megohms

### PHYSICAL DIMENSIONS

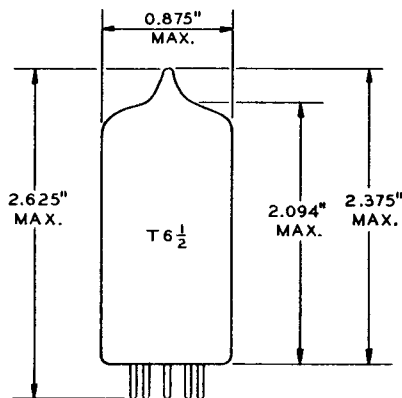

EIA 6-3

### TERMINAL CONNECTIONS

- Pin 1 - Cathode
- Pin 2 - Grid Number 1
- Pin 3 - Grid Number 3 (Suppressor) and Internal Shield
- Pin 4 - Heater
- Pin 5 - Heater
- Pin 6 - Heater Center Tap
- Pin 7 - Plate
- Pin 8 - Grid Number 2 (Screen)
- Pin 9 - Grid Number 3 (Suppressor) and Internal Shield

### BASING DIAGRAM

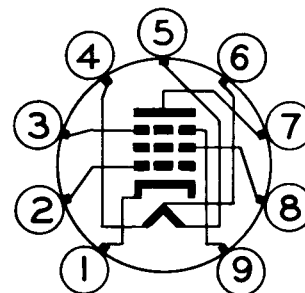

EIA 9BF

**MAXIMUM RATINGS (Cont'd)**

Design-Maximum ratings are limiting values of operating and environmental conditions applicable to a bogey electron tube of a specified type as defined by its published data and should not be exceeded under the worst probable conditions.

The tube manufacturer chooses these values to provide acceptable serviceability of the tube, making allowance for the effects of changes in operating conditions due to variations in the characteristics of the tube under consideration.

The equipment manufacturer should design so that initially and throughout life no design-maximum value for the intended service is exceeded with a bogey tube under the worst probable operating conditions with respect to supply-voltage variation, equipment component variation, equipment control adjustment, load variation, signal variation, environmental conditions, and variations in the characteristics of all other electron devices in the equipment.

**CHARACTERISTICS AND TYPICAL OPERATION**

**AVERAGE CHARACTERISTICS**

Plate Voltage . . . . .	50	250	Volts
Screen Voltage . . . . .	125	150	Volts
Grid-Number 1 Voltage . . . . .	0.04	0	Volts
Cathode-Bias Resistor . . . . .	---	56	Ohms
Plate Resistance, approximate . . . . .	---	50000	Ohms
Transconductance . . . . .	---	36000	Micromhos
Plate Current . . . . .	70	28	Milliamperes
Screen Current . . . . .	24	6.5	Milliamperes
Grid-Number 1 Voltage, approximate I <sub>b</sub> = 100 Microamperes . . . . .	---	-5.7	Volts

**NOTES**

- \* Operated with the two sections of the heater connected in parallel and the resulting combination in series with the heaters of other tubes having the same bogey heater current.
- ‡ Operated with the two sections of the heater connected in parallel and the resulting combination in parallel with the heaters of other tubes having the same bogey heater voltage.
- § Operated with the two sections of the heater connected in series and the resulting combination in parallel with the heaters of other tubes having the same bogey heater voltage.
- ¶ Heater voltage for a bogey tube at I<sub>f</sub> = 0.6 amperes.
- # For parallel heater operation, the equipment designer should design the equipment so that heater voltage is centered at the specified bogey value, with heater supply variations restricted to maintain heater voltage within the specified tolerance; for series heater operation, the equipment designer should design the equipment so that heater current is centered at the specified bogey value, with heater supply variations restricted to maintain heater current within the specified tolerance.
- Δ Heater current of a bogey tube at E<sub>f</sub> = 6.3 volts.
- ♠ Heater current of a bogey tube at E<sub>f</sub> = 12.6 volts.
- \*\* The time required for the voltage across the heater to reach 80 percent of the bogey value after applying 4 times the bogey heater voltage to a circuit consisting of the tube heater in series with a resistance equal to 3 times the bogey heater voltage divided by the bogey heater current.
- ‡‡ Without external shield.
- §§ Control grid to cathode spacing of this type is of such low order of magnitude as to preclude the use of voltage between these elements of more than 50 volts dc or peak ac in commercial tube checkers or shorts-indicating devices, particularly where mechanical excitation of the tube is employed.
- ¶¶ Applied for a short interval (two seconds maximum) so as not to damage tube.

The tubes and arrangements disclosed herein may be covered by patents of General Electric Company or others. Neither the disclosure of any information herein nor the sale of tubes by General Electric Company conveys any license under patent claims covering combinations of tubes with other devices or elements. In the absence of an

express written agreement to the contrary, General Electric Company assumes no liability for patent infringement arising out of any use of the tubes with other devices or elements by any purchaser of tubes or others.

SCREEN RATING CHART

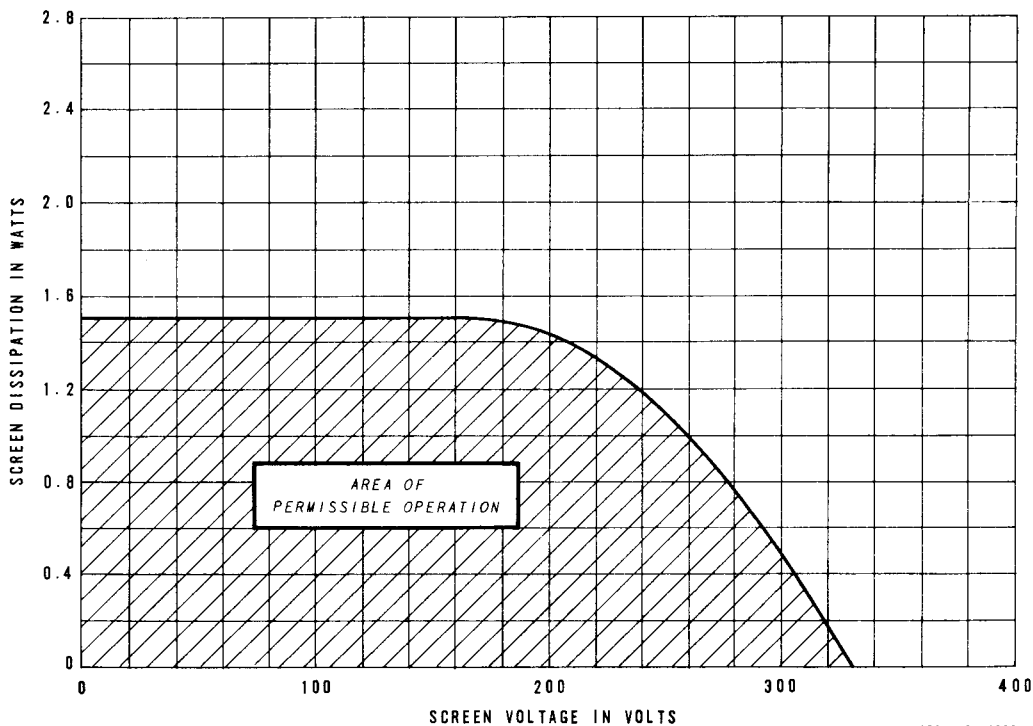

K-55811-TD323-1

APRIL 6, 1966

AVERAGE PLATE CHARACTERISTICS

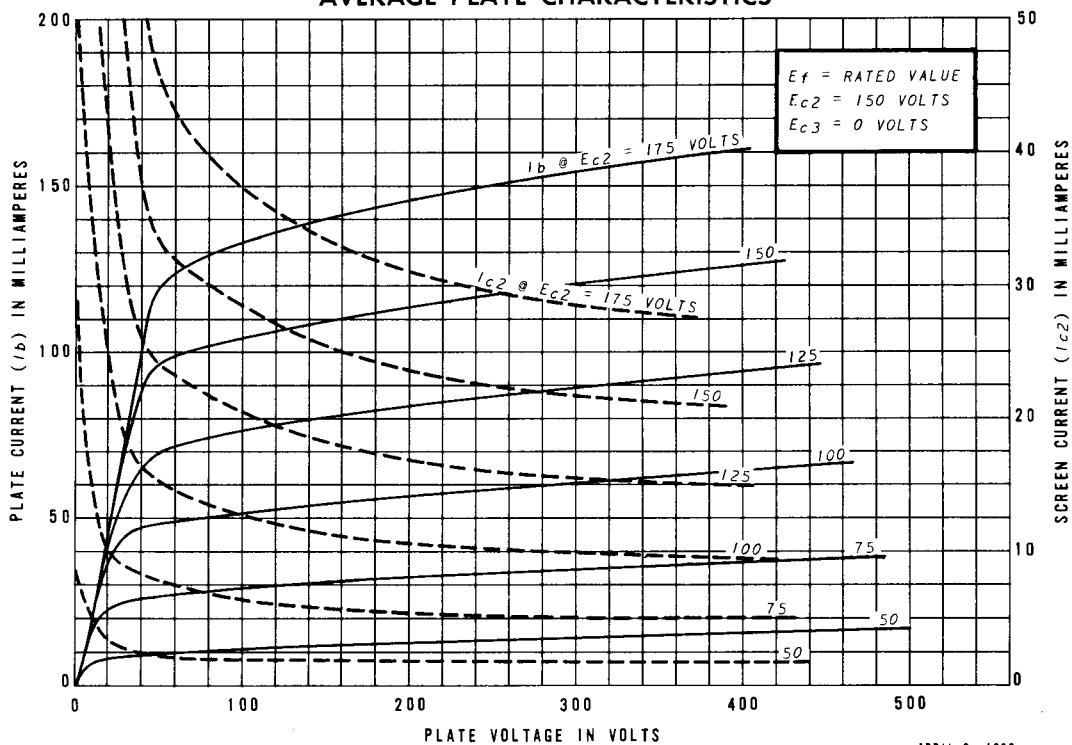

K-55811-TD323-2

APRIL 6, 1966

## AVERAGE PLATE CHARACTERISTICS

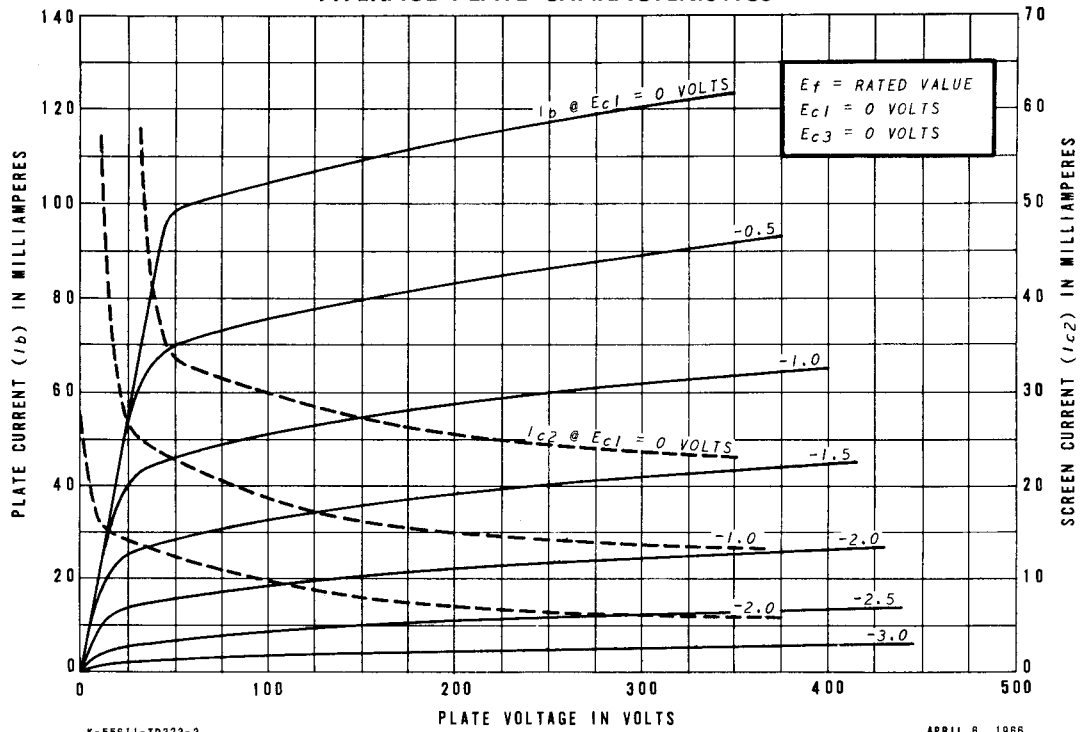

## AVERAGE TRANSFER CHARACTERISTICS

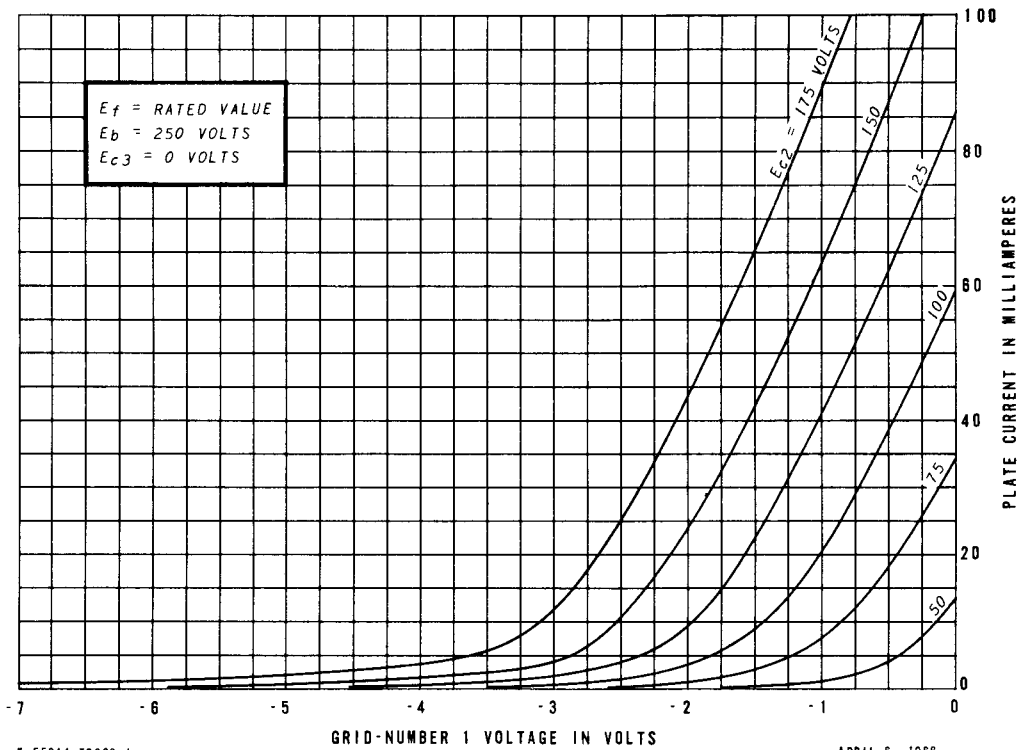

AVERAGE TRANSFER CHARACTERISTICS

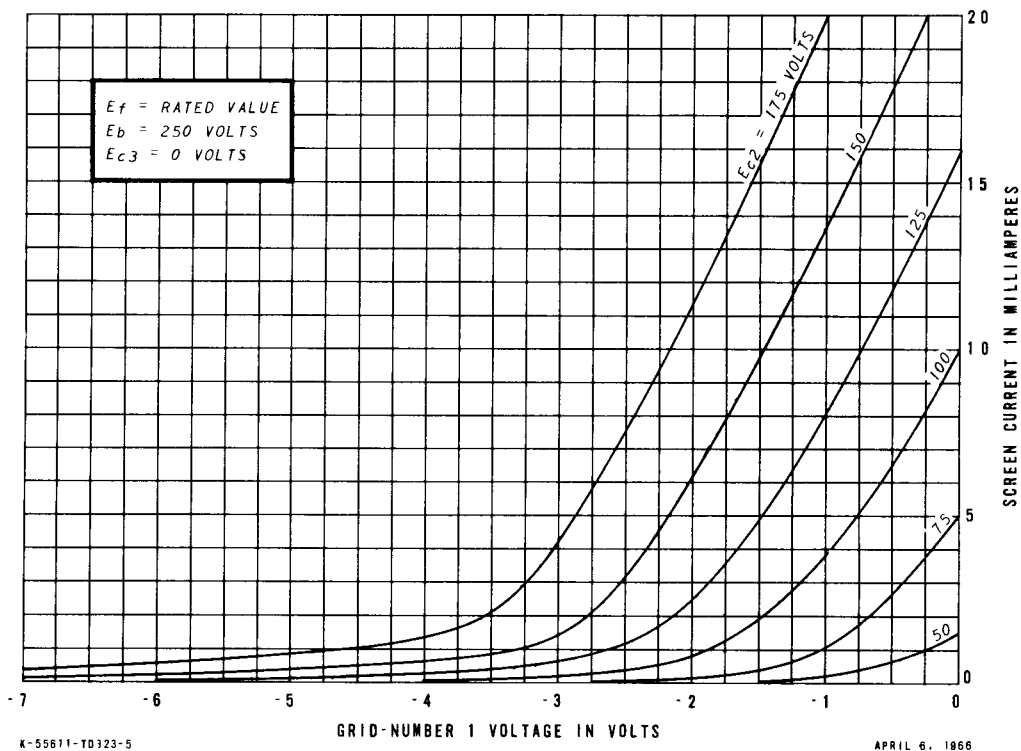

AVERAGE TRANSFER CHARACTERISTICS

