



12BV7

12BV7  
ET-T1315A  
Page 1  
1-59

PENTODE

FOR TV VIDEO AMPLIFIER APPLICATIONS

DESCRIPTION AND RATING

The 12BV7 is a miniature power pentode designed primarily for use as the video output amplifier in television receivers. In application and characteristics it is related to the 12BY7. Like the 12BY7 it features high transconductance, high power sensitivity, and low interelectrode capacitances. It can deliver relatively large output voltages with low values of plate-supply voltage and plate load resistance.

GENERAL

ELECTRICAL

Cathode—Coated Unipotential	Series	Parallel	
Heater Voltage, AC or DC.....	12.6	6.3	Volts
Heater Current.....	0.3	0.6	Amperes
Direct Interelectrode Capacitances*			
Grid-Number 1 to Plate.....	0.055		$\mu\mu\text{f}$
Input.....	.11		$\mu\mu\text{f}$
Output.....	.30		$\mu\mu\text{f}$

MECHANICAL

Mounting Position—Any  
Envelope—T-6½, Glass  
Base—E9-1, Small Button 9-Pin

MAXIMUM RATINGS

DESIGN-CENTER VALUES

Plate Voltage.....	300	Volts
Screen Voltage.....	175	Volts
Negative DC Grid-Number 1 Voltage.....	50	Volts
Plate Dissipation.....	6.25	Watts
Screen Dissipation.....	1.0	Watts
Heater-Cathode Voltage		
Heater Positive with Respect to Cathode		
DC Component.....	100	Volts
Total DC and Peak.....	200	Volts
Heater Negative with Respect to Cathode		
Total DC and Peak.....	200	Volts
Grid-Number 1 Circuit Resistance		
With Fixed Bias.....	0.25	Megohms
With Cathode Bias.....	1.0	Megohms

The tubes and arrangements disclosed herein may be covered by patents of General Electric Company or others. Neither the disclosure of any information herein nor the sale of tubes by General Electric Company conveys any license under patent claims covering combinations of tubes with other devices or elements. In the absence of an express written agreement to the contrary, General Electric Company assumes no liability for patent infringement arising out of any use of the tubes with other devices or elements by any purchaser of tubes or others.

BASING DIAGRAM

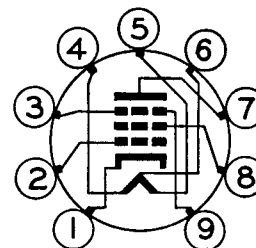

EIA 98F

TERMINAL CONNECTIONS

- Pin 1—Cathode
- Pin 2—Grid Number 1
- Pin 3—Internal Shield and Grid Number 3 (Suppressor)
- Pin 4—Heater
- Pin 5—Heater
- Pin 6—Heater Center-tap
- Pin 7—Plate
- Pin 8—Grid Number 2 (Screen)
- Pin 9—Internal Shield and Grid Number 3 (Suppressor)

PHYSICAL DIMENSIONS

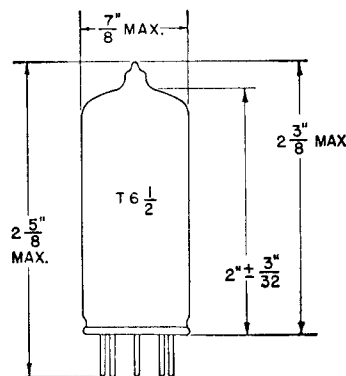

EIA 6-3



Supersedes ET-T1315, dated 4-56

## CHARACTERISTICS AND TYPICAL OPERATION

### CLASS A<sub>1</sub> AMPLIFIER

Plate Voltage .....	250	250	Volts
Suppressor, Connected to Cathode at Socket			
Screen Voltage .....	180	150	Volts
Grid-Number 1 Voltage .....	-8	—	Volts
Cathode-Bias Resistor .....	—	68	Ohms
Plate Resistance, approximate .....	—	85000	Ohms
Transconductance .....	—	13000	Micromhos
Plate Current .....	.05†	27	Milliamperes
Screen Current .....	—	6.0	Milliamperes
Grid-Number 1 Voltage, approximate			
I <sub>b</sub> = 20 Microamperes .....	—	-12	Volts
Triode Amplification Factor .....		28	

\* Without external shield.

† Minimum.

### AVERAGE PLATE CHARACTERISTICS

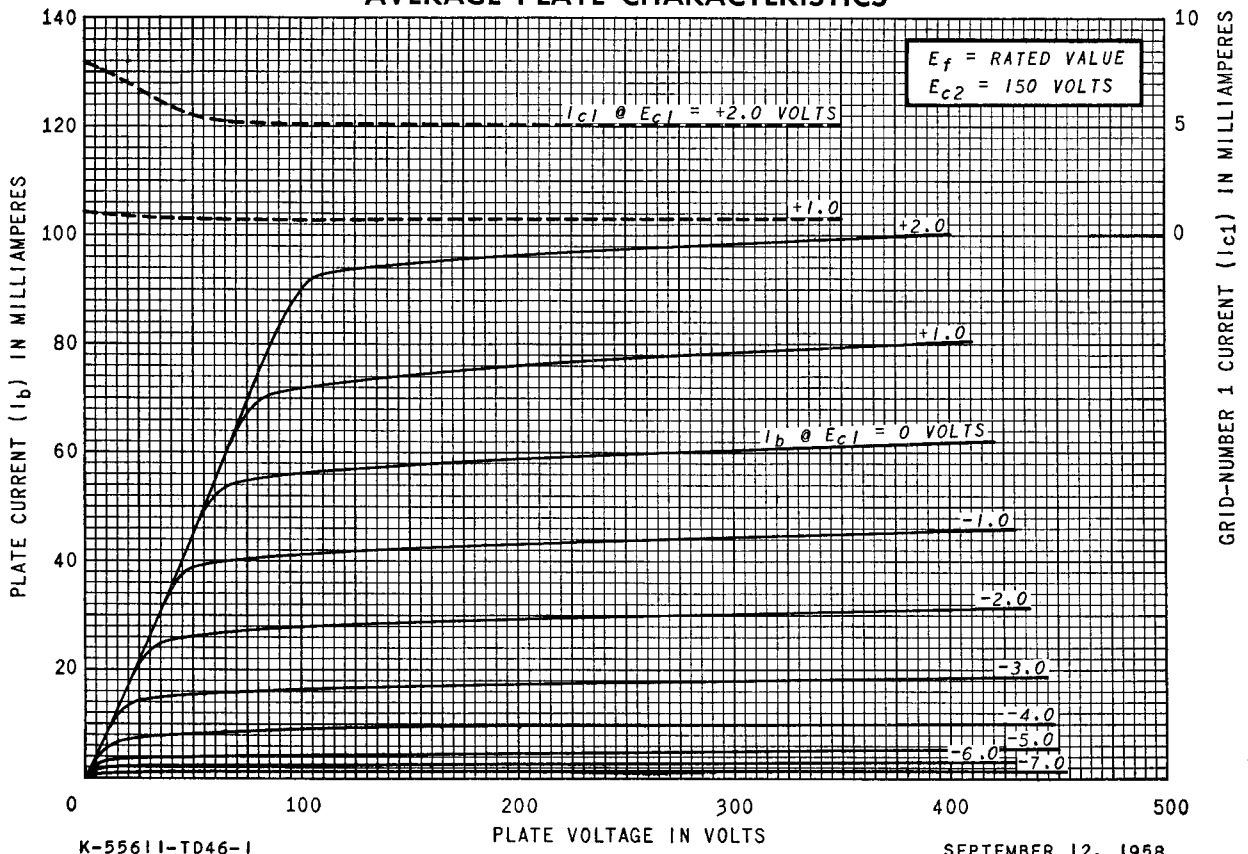

**AVERAGE SCREEN CHARACTERISTICS**

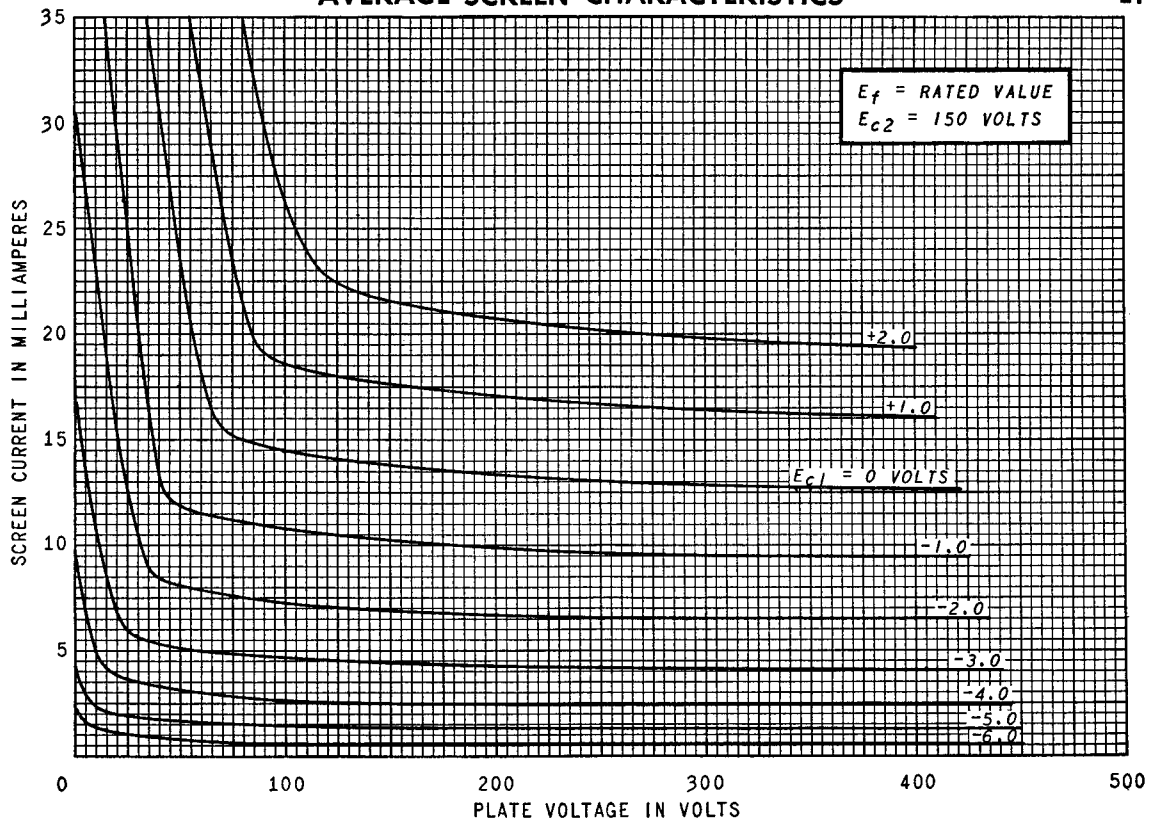

K-55611-TD46-2

SEPTEMBER 12, 1958

**AVERAGE PLATE CHARACTERISTICS**

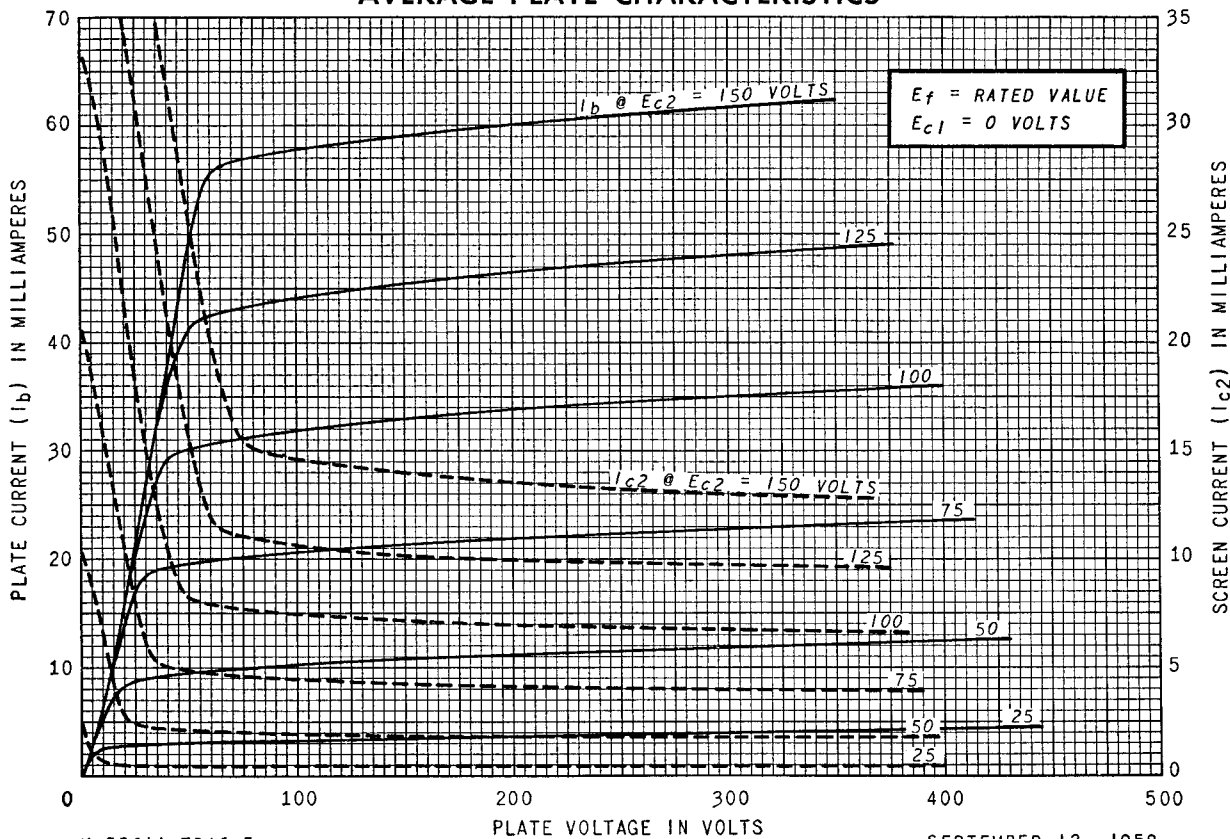

K-55611-TD46-3

SEPTEMBER 12, 1958

### AVERAGE TRANSFER CHARACTERISTICS

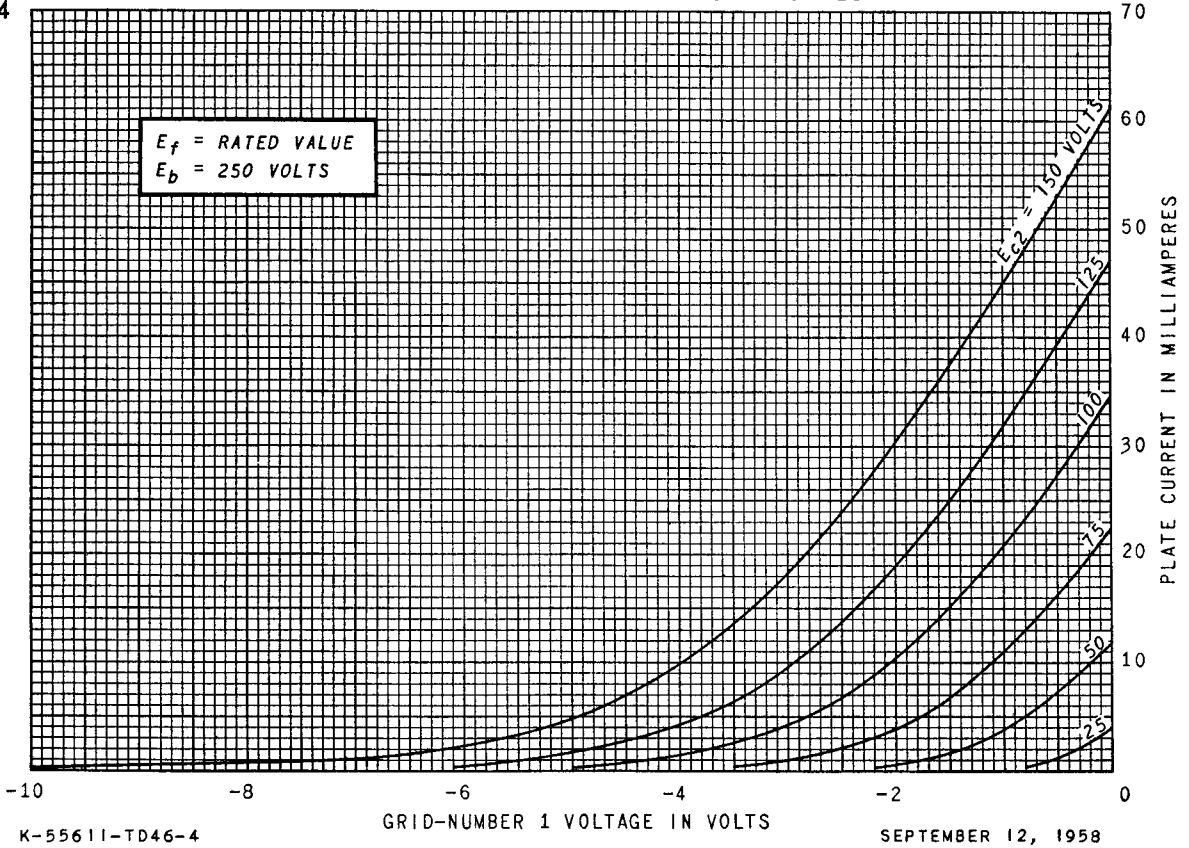

### AVERAGE TRANSFER CHARACTERISTICS

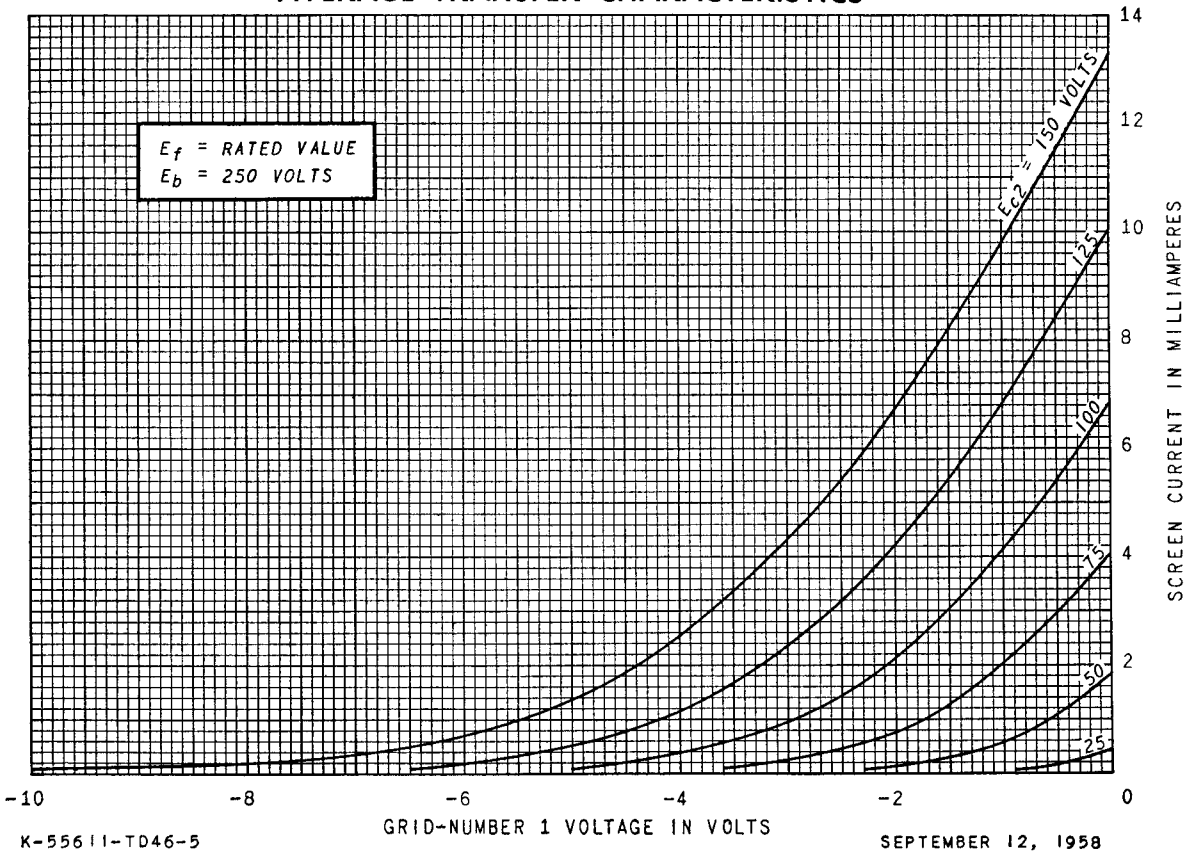

### AVERAGE TRANSFER CHARACTERISTICS

